



Phoenix Smart IP43 Charger

12/30, 12/50, 24/16, 24/25 | (1+1) & (3) Output |
120-240V

Rev. 07 - 09/2022

This manual is also available in [HTML5](#).

Table of Contents

1. Safety instructions	1
2. Quick start guide	3
3. Features	5
4. Operation	7
4.1. Charge algorithm	7
4.2. Temperature compensation	9
4.3. VE.Smart Networking	10
4.3.1. Voltage, temperature and current sense	10
4.3.2. Synchronised charging	10
4.4. Multiple battery outputs	12
4.5. Commencing a new charge cycle	13
4.6. Estimating charge time	14
5. Installation	15
5.1. Mounting	15
5.2. Wiring	16
5.2.1. Cable and fusing	16
5.2.2. Remote on/off	17
5.2.3. Programmable relay	17
5.2.4. Schematics	18
6. Setup	22
6.1. Charge modes	22
6.1.1. Charge voltage	22
6.1.2. Recondition mode	22
6.1.3. Low current mode	22
6.2. Using the MODE button	23
6.3. Using VictronConnect	24
6.4. Bluetooth	27
6.4.1. Changing the PIN code	27
6.4.2. Resetting the PIN code	29
6.4.3. Disabling Bluetooth	30
6.4.4. Re-enabling Bluetooth	32
6.5. VE.Smart Networking	33
6.5.1. Voltage, temperature and current sense	33
6.5.2. Synchronised charging	38
6.6. System reset	44
7. Monitoring	45
7.1. LED indications	45
7.1.1. Operation states	45
7.1.2. Error states	45
7.2. VictronConnect	46
7.2.1. Status screen	46
7.2.2. Graph screen	47
7.2.3. History screen	48
8. Advanced Configuration	50
8.1. Advanced settings	50
8.2. Expert mode settings	53
8.3. Power supply function	56
9. Technical specifications	57
10. Warranty	58

1. Safety instructions



WARNING: CAREFULLY READ AND FOLLOW ALL SAFETY INSTRUCTIONS

- Carefully read the manual **before** the charger is installed and operated; retain the manual in a safe place for future reference.
- The charger must **not** be installed or operated by any of the following persons, unless they are under strict instruction and supervision:
 - a. Anyone who lacks the appropriate knowledge, experience or competence, required for safe installation and/or usage.
 - b. Anyone with compromised/reduced physical, sensory or mental capabilities, which may effect safe installation and/or usage (including children).
- **Charger installation and operation**
 - a. Install the charger in a location with good natural airflow/ventilation and sufficient unobstructed space around it; refer to the the 'Installation' section for more detail.
 - b. Install the charger on a non-flammable substrate and ensure there are no heat-sensitive items in the immediate vicinity; it is normal for the charger to become hot during operation.
 - c. Install the charger in a location where it is protected from environmental conditions such as direct sunlight, water, high moisture and dust, and also located well away from any flammable liquids or gasses.
Charger is for indoor use only.
 - d. Do not install or place/operate the charger on top of the battery, directly above the battery, or in a sealed compartment with the battery; batteries can emit explosive gasses.
 - e. Do not cover or place any other items on top of the charger.
- **Battery installation and charging**
 - a. Install and charge the battery in a location with good natural airflow/ventilation.
 - b. Ensure that there are no ignition sources near the battery; batteries can emit explosive gasses.
 - c. Battery acid is corrosive; if battery acid comes into contact with skin immediately rinse with water.
 - d. Do not charge non-rechargeable batteries or Li-ion batteries if the battery temperature is below 0°C.
- **Battery DC connections**
 - a. Ensure that the DC system is fully shut down/isolated prior to disconnection of any existing cabling and/or new connections are made to the battery/DC system.
 - b. Use flexible multi stranded copper cable with sufficient cross sectional area, inline with an appropriate fuse or circuit breaker; refer to the 'Installation' section for more detail.
- **Mains supply AC connection**
 - a. AC connection to the mains supply must be in accordance with local electrical regulations. The charger must be plugged into an earthed AC mains power outlet.
 - b. Do not operate the charger if the AC power cable is damaged, contact a service agent.
- **Charger setup**
 - a. Refer to the battery manufacturers instructions and specifications to ensure the battery is suitable for use with this charger and confirm the recommended charge settings.
 - b. The integrated charge modes (selected via the MODE button or VictronConnect app) combined with adaptive charge logic are well suited for most common battery types; such as flooded lead-acid, AGM, Gel and LiFePO4.
If necessary, advanced configuration with user defined settings is possible using the VictronConnect app and a Bluetooth enabled device (such as a mobile phone or tablet).

2. Quick start guide

1. Mount the charger vertically (with terminals facing down) on a non-flammable substrate; secure using the 4 mounting holes on the base. Ensure there is at least 10cm of clearance below and above the charger for airflow/cooling.
2. Connect DC cabling between the charger's BATTERY terminals and the battery or DC system distribution bus; all LEDs will illuminate briefly when DC power is connected.

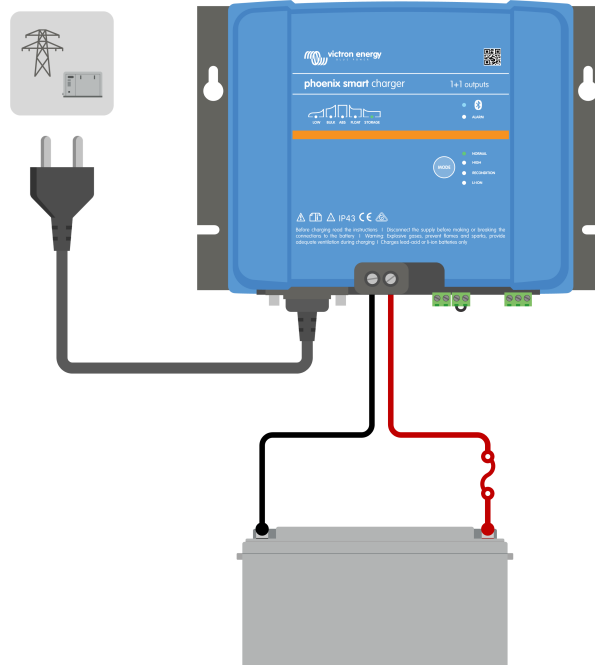

- a. Ensure that the DC system is fully shut down (all DC loads and charge sources off/isolated) prior to disconnection of any existing battery/DC system distribution bus cabling and connection of the charger to the battery terminals/DC system distribution bus.
 - b. Use flexible multi stranded copper cable with sufficient cross sectional area, inline with an appropriate fuse or circuit breaker.
 - c. Ensure that wiring polarity is correct; use red cabling for the + (positive) connections and black cabling for the - (negative) connections.
3. Connect the AC power cable to a mains power outlet; all LEDs will illuminate briefly when the charger is powered up, then the LED indicating the charge state will illuminate.

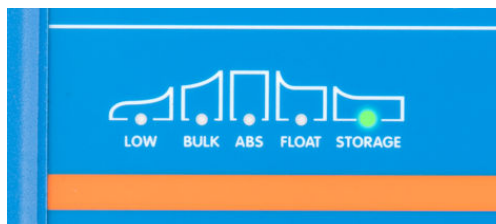

4. Configure the charge settings as required for the battery type and capacity.
 - a. **Using the mode button:**
 - a. Briefly press the MODE button to cycle through the available options and select the most appropriate charge preset; the LED beside the currently selected charge mode will be illuminated. When recondition mode is selected, the RECONDITION LED will be illuminated in addition to the selected charge mode LED.
 - b. If required, activate low current mode (reduced charge current); depress and hold the MODE button for 3 seconds, when activated the LOW LED will blink.



- b. **Using VictronConnect:**
 - i. Using a Bluetooth enabled device (such as a mobile phone or tablet), open the **VictronConnect** app and locate the **Phoenix Smart IP43 Charger** in the LOCAL page, then connect to the device (default Bluetooth PIN Code is 000000).
 - ii. Access the 'Settings' menu by selecting the 'Settings' icon (gear) in the top right corner, then enter the 'Battery settings' menu.
 - iii. Expand the 'Battery preset' drop-down menu, then select 'Built-in preset' or alternatively 'Select preset' for more specialised battery types. Review the available options and select the most appropriate charge preset; once selected confirm that the new charge voltages and settings are correct/suitable.

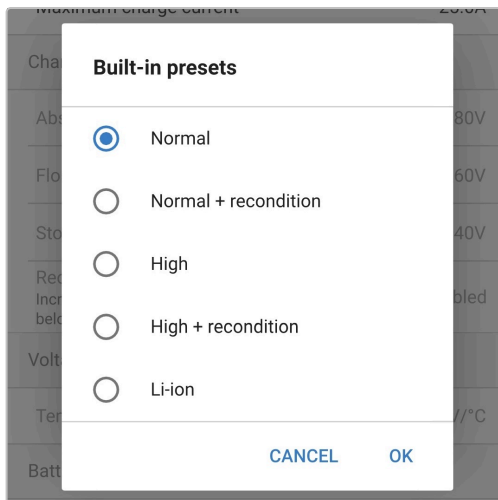

The charger will automatically store the selected charge mode and recall it for future charge cycles (even after being disconnected from power).

5. When the ABS LED is illuminated the charger has moved into absorption stage (bulk stage is complete); the battery will be approximately 80% charged (or >95% for Li-ion batteries) and may be returned into service if required.
6. When the FLOAT LED is illuminated the charger has moved into float stage (absorption stage is complete); the battery will be fully (100%) charged and is ready to be returned into service.
7. When the STORAGE LED is illuminated the charger has moved into storage mode (float stage is concluded); to maintain the battery at full charge, the battery can be left on continuous charge for an extended duration.
8. Disconnect the AC power cable from the mains power outlet at any time to stop charging.

3. Features

a. Bluetooth setup and monitoring (Using VictronConnect)

Equipped with integrated Bluetooth; enabling quick and simple setup, advanced configuration, comprehensive monitoring and firmware updates via the **VictronConnect** app and a Bluetooth enabled device (such as a mobile phone or tablet).

b. VE.Smart Network compatible

VE.Smart Networking capability allows multiple chargers to operate in unison with synchronised charging, and receive accurate battery voltage (Voltsense), charge current (Current-sense) and battery temperature (Temp-sense) data from a compatible battery monitor (such as a BMV, SmartShunt, Smart Battery Sense or VE.Bus Smart Dongle) to further enhance the charge cycle.

c. VE.Direct interface

Fully integrate with a **GX device** (such as a Cerbo GX) via VE.Direct interface, enabling system monitoring and control from a single device and connectivity to the **VRM** (Victron Remote Monitoring) portal for data logging and remote access to real time monitoring, as well as control of the charger.

d. Integrated charge presets

Integrated charge presets (selected via the MODE button or VictronConnect app) combined with adaptive charge logic are well suited for most common battery types; such as LiFePO4, AGM, Gel and flooded lead-acid. Advanced configuration with specific user defined settings is also possible using VictronConnect.

e. Multi-stage charge algorithm

The multi-stage charge algorithm is specifically engineered to optimise each recharge cycle and charge maintenance over extended periods.

f. Adaptive absorption

Adaptive absorption monitors the battery's response during initial charging and intelligently determines the appropriate absorption duration for each individual charge cycle. This ensures that the battery is fully recharged regardless of the discharge level or capacity and avoids excessive time at the elevated absorption voltage (that can accelerate battery aging).

g. Temperature compensation

Charge voltage is automatically compensated depending on the ambient temperature; this ensures that the battery is charged at the optimal charge voltage regardless of the climate and avoids the need for manual settings adjustments. Temperature compensation is not required and automatically disabled when in LI-ION charge mode.

h. High efficiency

The **Phoenix Smart IP43 Charger** range is up to ~96% efficient; resulting in lower power usage, less heat generated and cooler operation

i. Durable and safe

- i. Engineered to provide years of trouble-free and dependable operation in all usage conditions
- ii. Protection against overheating: output current will be reduced if the charger temperature increases above 40°C (linear derate from 100% at 40°C to 20% at 60°C)
- iii. Protection against output short circuit
- iv. Protection against reverse polarity connection (internal fuse - not replaceable)

j. Silent operation

Totally silent operation since there is no cooling fan or moving parts, cooling is via natural convection; full rated output current is still provided up to an ambient temperature of 40°C.

k. Lithium Ion compatible

Compatible with Li-ion (LiFePO₄) batteries; when the integrated LI-ION charge mode is selected the charge cycle settings are altered to suit.

If the charger is connected to a battery where under voltage protection (UVP) has tripped, the **Phoenix Smart IP43 Charger** range will automatically reset UVP and start charging; many other chargers will not recognise a battery in this state.

Warning: Do not charge Li-ion batteries if the battery temperature is below 0°C.

l. Storage stage

An additional stage to extend battery life whilst the battery is unused and on continuous charge.

m. Recondition stage

An optional stage that can partially recover/reverse lead acid battery degradation due to sulfation; typically caused by inadequate charging or if the battery is left in a deeply discharged state.

n. **Configurable output current**

A configurable setting that limits the maximum charge current to a reduced level; beneficial when charging lower capacity batteries with a high current charger.

o. **Recovery function**

The **Phoenix Smart IP43 Charger** range will attempt to recharge a severely discharged battery (even down to 0V) with low current and then resume normal charging once the battery voltage has risen sufficiently - many other chargers will not recognise a battery in this state.

p. **Power supply mode**

A specific mode to use the charger as a DC power supply; to power equipment at a constant voltage with or without a battery connected.

4. Operation

4.1. Charge algorithm

The Victron **Phoenix Smart IP43 Charger** range are intelligent multi-stage battery chargers, specifically engineered to optimise each recharge cycle and charge maintenance over extended periods.

The multi-stage charge algorithm includes the individual charge stages described below:

1. Bulk

The battery is charged at maximum charge current until the voltage increases to the configured absorption voltage.

The bulk stage duration is dependent on the battery's level of discharge, the battery capacity and the charge current.

Once the bulk stage is complete, the battery will be approximately 80% charged (or >95% for Li-ion batteries) and may be returned into service if required.

2. Absorption

The battery is charged at the configured absorption voltage, with the charge current slowly decreasing as the battery approaches full charge.

The default absorption stage duration is adaptive and intelligently varied depending on the battery's level of discharge – this is determined from the duration of the bulk charge stage.

Adaptive absorption stage duration can vary between a minimum of 30 minutes, up to a maximum limit of 8 hours (or as configured) for a deeply discharged battery.

Alternatively, fixed absorption duration can be selected; fixed absorption duration is the automatic default when Li-ion mode is selected.

Absorption stage can also be ended early based on the tail current condition (if enabled), which is when the charge current drops below the tail current threshold.

3. Recondition

The battery voltage is attempted to be increased to the configured recondition voltage, while the charger output current is regulated to 8% of the nominal charge current (for example - 1.2A maximum for a 15A charger).

Recondition is an optional charge stage for lead acid batteries and not recommended for regular/cyclic use - use only if required, as unnecessary or overuse will reduce battery life due to excessive gassing.

The higher charge voltage during recondition stage can partially recover/reverse battery degradation due to sulfation, typically caused by inadequate charging or if the battery is left in a deeply discharged state for an extended period (if performed in time).

The recondition stage may also be applied to flooded batteries occasionally to equalise individual cell voltages and prevent acid stratification.

Recondition stage is terminated as soon as the battery voltage increases to the configured recondition voltage or after a maximum duration of 1 hour (or as configured).

Note that in certain conditions it is possible for the recondition state to end before the configured recondition voltage is achieved, such as when the charger is simultaneously powering loads, if the battery was not fully charged before recondition stage commenced, if the recondition duration is too short (set to less than one hour) or if the charger output current is insufficient in proportion to the capacity of the battery/battery bank.

4. Float

The battery voltage is maintained at the configured float voltage to prevent discharge.

Once float stage is commenced the battery is fully charged and ready for use.

The float stage duration is also adaptive and varied between 4 to 8 hours depending on the duration of the absorption charge stage, at which point the charger determines the battery to be in storage stage.

5. Storage

The battery voltage is maintained at the configured storage voltage, which is slightly reduced compared to the float voltage to minimise gassing and extend battery life whilst the battery is unused and on continuous charge.

6. Repeated absorption

To refresh the battery and prevent slow self-discharge while in storage stage over an extended period, a 1 hour absorption charge will automatically occur every 7 days (or as configured).

The indicator LEDs display the active charge state; refer to the image below:

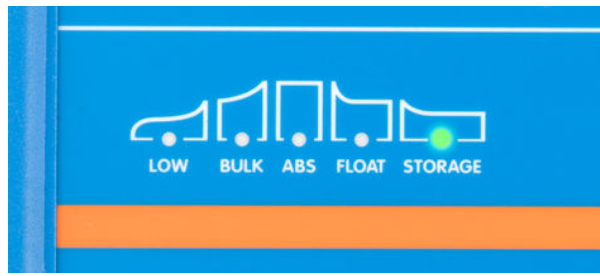

4.2. Temperature compensation

The Victron **Phoenix Smart IP43 Charger** range will automatically compensate the configured charge voltage based on ambient temperature (except for Li-ion mode or if manually disabled).

The optimal charge voltage of a lead acid battery varies inversely with battery temperature; automatic temperature-based charge voltage compensation avoids the need for special charge voltage settings in hot or cold environments.

During power up the charger will measure its internal temperature and use that temperature as the reference for temperature compensation, however the initial temperature measurement is limited to 25°C as it's unknown if the charger is still warm from earlier operation.

Since the charger generates some heat during operation, the internal temperature measurement is only used dynamically if the internal temperature measurement is considered reliable; when the charge current has decreased to a low/negligible level and adequate time has elapsed for the charger's temperature to stabilise.

For more accurate temperature compensation, battery temperature data can be sourced from a compatible battery monitor (such as a BMV, SmartShunt, Smart Battery Sense or VE.Bus Smart Dongle) via VE.Smart Networking - refer to the 'Operation - VE.Smart Networking' section for more information.

The configured charge voltage is related to a nominal temperature of 25°C and linear temperature compensation occurs between the limits of 6°C and 50°C based on the default temperature compensation coefficient of -16.2mV/°C (-32.4mV/°C for 24V chargers / -8.1mV/°C for 6V chargers) or as configured.

The temperature compensation coefficient is specified in mV/°C and applies to the entire battery/battery bank (not per battery cell).

Charge Voltage - Temperature Compensation

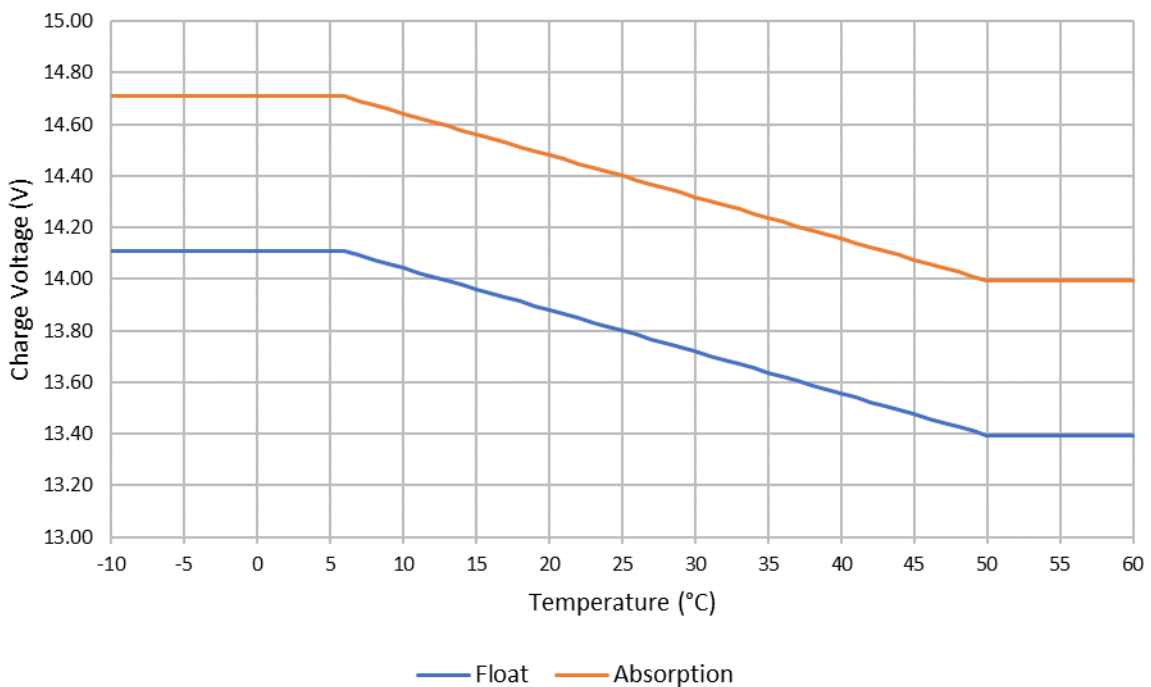

4.3. VE.Smart Networking

VE.Smart Networking enables Bluetooth connectivity and communication between multiple Victron products.

This powerful feature enables chargers to receive accurate battery voltage (Volt-sense), charge current (Current-sense) and battery temperature (Temp-sense) data from a compatible battery monitor (such as a BMV, SmartShunt, Smart Battery Sense or VE.Bus Smart Dongle) and/or multiple chargers to operate in unison with synchronised charging to further enhance the charge cycle.

4.3.1. Voltage, temperature and current sense

Voltage Sense uses battery voltage data that is accurately measured directly at the battery terminals (or very close) and provides it to the charger, the charger then uses this voltage data to dynamically increase the output voltage and precisely compensate for voltage drop in the cabling and connections between the charger and battery.

This enables the battery to be charged with the exact voltage as configured in the charger, instead of a lower voltage due to voltage drop in the cabling and connections.

Voltage drop is proportional to the charge current and cabling/connection resistance ($V=I \times R$), so voltage drop will vary during a charge cycle and can be quite significant when charging at higher charge currents through cabling and connections with higher than optimal resistance; in this scenario voltage sense will be particularly beneficial.

Note that voltage sense does **not** allow inadequately rated cabling or connections to be used, for reliable and safe operation cabling and connections must always be rated to carry the maximum current (including the fault current required to blow the fuse/trip the breaker) in the particular installation conditions.

Temperature Sense uses battery temperature data that is accurately measured directly at a battery terminal or on the battery body and provides it to the charger, the charger then uses this temperature data to dynamically compensate the charge voltage (decrease or increase) according to the specified temperature coefficient ($X \text{ mV}/^{\circ}\text{C}$).

The optimal charge voltage of a lead acid based battery varies inversely with battery temperature with the nominal charge voltage specified at 25°C; automatic temperature-based charge voltage compensation avoids the need for manual charge voltage setting adjustments in hot or cold environments.

For lithium batteries the optimal charge voltage remains constant under all normal operating temperatures, however lithium batteries can be permanently damaged if charged in cold conditions; in this case the temperature sense data can be used to automatically disable charging in cold conditions (typically $<5^{\circ}\text{C}$).

Current Sense uses battery current data that is measured by the battery monitor shunt (requires a BMV or SmartShunt) and provides it to the charger, the charger then references this current data (as opposed to the charger output current) for the tail current setting.

The tail current setting references the diminishing level of charge current (typical at the end of a full charge cycle) in relation to the trigger threshold to determine when the battery is fully charged and consequently when the absorption stage can be ended (prior to the absorption stage time limit being reached). The use of tail current to end absorption stage is a highly effective and common method used to properly charge lead acid based batteries.

In order to end the absorption phase at the correct point, it is important that the true current flow into the battery is referenced in relation to the tail current threshold, rather than the charger output current which may be significantly higher; if any loads are powered while charging a portion of the charger output current will be flowing directly to the loads, making the tail current condition more difficult or impossible to meet without current sense.

Multiple compatible chargers can be added to a common VE.Smart network and receive voltage, temperature and/or current sense data from the same battery monitor. Once multiple compatible chargers are in a common VE.Smart network their charge algorithms will also be synchronised, refer to the 'Synchronised charging' section for more information.

4.3.2. Synchronised charging

Synchronised charging capability enables multiple compatible chargers to be combined together in a common VE.Smart network, allowing the chargers to operate in unison as if they were one large charger.

The chargers will synchronise the charge algorithm between themselves with no further hardware or physical connections required, and simultaneously change charge states.

Synchronised charging works by systematically prioritising all chargers and assigning one as the 'master', this charger then controls the charge stage of all other 'slave' chargers. In case the initial 'master' is disconnected from the VE.Smart Network for any reason (out of Bluetooth range for example), another charger will be systematically reassigned as the 'master' and take over control; this can also be reversed if communication with the initial 'master' (that has a higher priority) is re-established. The 'master' charger can not be manually selected.

Synchronised charging does not regulate or equalise the current output of multiple chargers, each charger still has total control over its own current output. Accordingly, current output variation between multiple chargers is normal (dependent on cable resistance and other factors) and a total system current output limit cannot be configured. For systems where a total system current output limit is important, consider using a GX device with DVCC instead.

Synchronised charging can be setup with different model chargers, providing they are VE.Smart Networking compatible (this includes VE.Smart Networking compatible Blue Smart chargers, Phoenix Smart chargers and MPPT solar chargers). Charging from MPPT solar chargers is not prioritised over mains supply chargers, so in some installations (dependent on cable resistance and other factors) and charging conditions it is possible for solar power to be underutilised.

Synchronised charging can also be used in conjunction with a battery monitor (BMV, SmartShunt, Smart Battery Sense or VE.Bus Smart Dongle) to provide voltage, temperature and/or current sense data to the chargers in a common VE.Smart network, refer to the 'Voltage, temperature and current sense' section for more information.

In the absence of a battery monitor providing current-sense data (requires a BMV or SmartShunt), the charge current from each individual charger is combined by the 'master' and referenced against the tail current setting.

4.4. Multiple battery outputs

The 1+1 and 3 output version chargers both have an integrated FET battery isolator and therefore feature separate isolated outputs.

With 1+1 output models, the main output can supply the full rated current and the starter/auxiliary output is limited to a maximum of 4A; however the combined current of all outputs is limited to the full rated current.

With the 3 output models, all 3 outputs can supply the full rated output current; however the combined current of all outputs is limited to the full rated output current.

Multiple isolated outputs make it possible for a single charger to charge multiple batteries, while keeping the batteries isolated from each other.



Note: Multiple outputs are not regulated individually, one charge algorithm (charge cycle and charge voltage) is applied to all outputs.

4.5. Commencing a new charge cycle

A new charge cycle will commence when:

1. Bulk stage is complete and the current output increases to the maximum charge current for four seconds (due to a simultaneously connected load)
2. If re-bulk current is configured; the current output exceeds the re-bulk current in float or storage stage for four seconds (due to a simultaneously connected load)
3. The MODE button is pressed or used to select a new charge mode.
4. VictronConnect is used to select a new charge mode or change the function from 'Power Supply' to 'Charger' mode
5. VictronConnect is used to disable and re-enable the charger (via the switch in the settings menu).
6. The remote terminals are used to disable and re-enable the charger (from an external switch or BMS signal)
7. The AC supply has been disconnected and reconnected

4.6. Estimating charge time

A lead acid battery is at approximately 80% state of charge (SOC) when the bulk charge stage is completed.

The bulk stage duration T_{bulk} can be calculated as $T_{\text{bulk}} = Ah / I$, where I is the charge current (excluding any loads) and Ah is the depleted battery capacity below 80% SOC.

An absorption period T_{abs} of up to 8 hours may be required to fully recharge a deeply discharged battery.

For example, the charge time of a fully discharged 100Ah battery when charged with a 10A charger to approximately 80% SOC is $T_{\text{bulk}} = 100 \times 80\% / 10 = 8$ hours.

Including an absorption duration of $T_{\text{abs}} = 8$ hours, the total estimated charge time would be $T_{\text{total}} = T_{\text{bulk}} + T_{\text{abs}} = 8 + 8 = 16$ hours. A Li-ion battery is more than 95% charged at the end of the bulk stage and reaches 100% charge after approximately 30 minutes of absorption charge.

5. Installation

5.1. Mounting

The Phoenix Smart IP43 Charger range is designed to be wall mounted using the flanges which protrude from either side of the heatsink.

Before mounting, the following aspects should be considered to identify/provide a suitable and safe location:

- Install the charger in a location with good natural airflow/ventilation; in case airflow is restricted, consider adding a cooling fan.
- Ensure there is sufficient unobstructed space around the charger; a minimum clearance of 100mm above and below is recommended.
- Install the charger on a non-flammable substrate and ensure there are no heat-sensitive items in the immediate vicinity; it is normal for the charger to become hot during operation.
- Install the charger in a location where it is protected from environmental conditions such as water, high moisture and dust, and also located well away from any flammable liquids or gasses.
- Do not install or place/operate the charger on top of the battery, directly above the battery, or in a sealed compartment with the battery; batteries can emit explosive gasses.
- Do not cover or place any other items on top of the charger.

Mount the charger vertically with terminals facing down; secure using the 4 mounting holes/slots on the base.

To aid installation, it is recommended to 'hang' the unit using the 2 upper screws and then add the 2 lower screws, before fully securing all 4 screws.

Use well fitting pan/flange head screws to secure the unit, ensure that the screw thread outer diameter is a clearance fit within the flange holes/slots (~5.5mm max OD).

Refer to the drawing below for mounting dimensions:

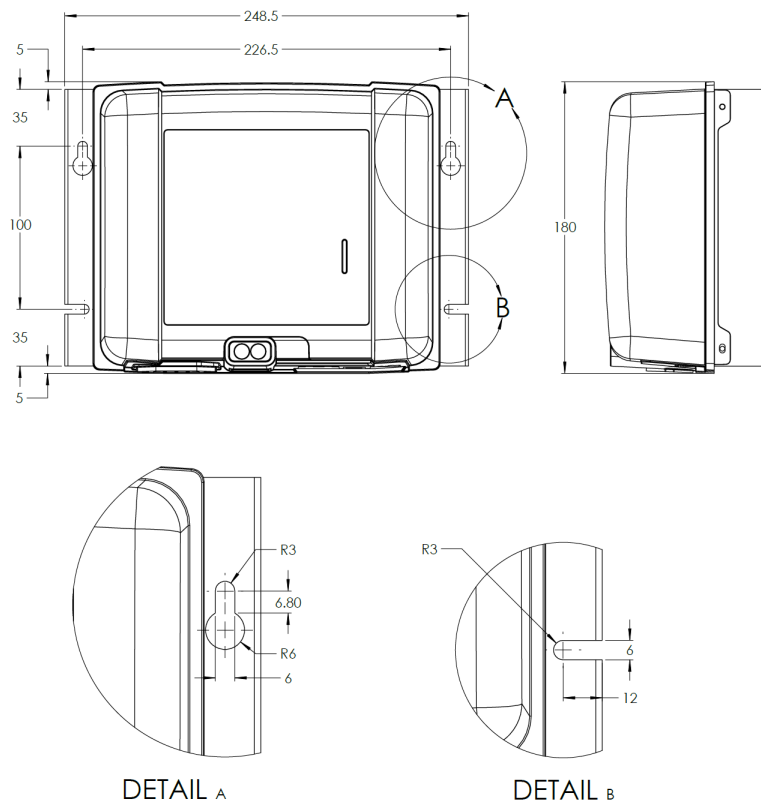

5.2. Wiring

Connect DC cabling between the charger's BATTERY terminals and the battery/batteries or DC system distribution bus; all LEDs will illuminate briefly when DC power is connected.

- Ensure that the DC system is fully shut down (all DC loads and charge sources off/isolated) prior to disconnection of any existing battery/DC system distribution bus cabling and connection of the charger to the battery terminals/DC system distribution bus.
- Ensure that wiring polarity is correct; use red cabling for the + (positive) connections and black cabling for the - (negative) connections.
- Use flexible multi stranded copper cable with sufficient cross sectional area, inline with an appropriate fuse or circuit breaker; refer to the 'Installation - Cable and fusing' section for more information.
- Refer to the 'Installation - Schematics' section for wiring schematic diagrams; wiring configuration for most typical installations are shown.

Connect any required communication cabling (VE.Direct) and/or control wiring (remote on/off and/or programmable relay).

Connect the AC power cable to a mains power outlet; all LEDs will illuminate briefly when the charger is powered up, then the LED indicating the charge state will illuminate.

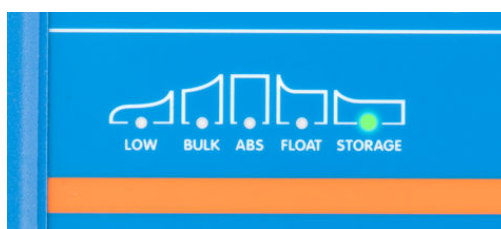

5.2.1. Cable and fusing

To enable proper and safe operation it is important to select and use suitably rated DC cabling, combined with a suitably rated inline fuse or circuit breaker.

Cable type/specification selection should consider the following aspects:

- Use flexible multi-stranded copper cable; the diameter of each individual strand should not exceed 0.4mm (0.016 inch) or a surface area of 0.125mm² (AWG26).
In case cable with thicker strand diameter is used the contact area will be insufficient and cause excessive resistance at the terminations/connections, this will generate heat and subsequently result in severe overheating or a fire.
Power cable with a flexibility class of 5 or higher is recommended (according to VDE 0295, IEC 60228 and BS6360).
- Use cable with high quality insulation; ensure that the cable voltage rating is in excess of the maximum operating voltage.
Power cable with a 0.6/1kV voltage rating is recommended.
- Use cable with a maximum operating temperature rating of at least 90°C (194°F).

Cable gauge/cross sectional area selection should consider the following aspects:

- The cable must have sufficient cross sectional area to safely withstand the fault current required to blow the fuse / trip the circuit breaker (not just the maximum operating current).
- The cable must have sufficient cross sectional area to prevent overheating when operating continuously at maximum operating current.
- The cable must have sufficient cross sectional area to avoid excessive voltage drop between the charger and battery, this is related to maximum operating current and cable length.

It is recommended to size cable gauge/cross sectional area for a maximum of 2% voltage drop at maximum operating current.

Refer to the table below for the minimum recommended conductor cross sectional area (in relation to cable length) and the recommended fuse/circuit breaker rating:

Charger model	Fuse / circuit breaker	Conductor area <5m		Conductor area 5-10m	
		mm ²	AWG	mm ²	AWG
Phoenix Smart IP43 Charger 12/30	40 - 50A	10mm ²	8 AWG	16mm ²	6 AWG
Phoenix Smart IP43 Charger 12/50	60 - 75A	16mm ²	6 AWG	16mm ²	6 AWG
Phoenix Smart IP43 Charger 24/16	20 - 25A	6mm ²	10 AWG	10mm ²	8 AWG
Phoenix Smart IP43 Charger 24/25	30 - 40A	10mm ²	8 AWG	16mm ²	6 AWG

5.2.2. Remote on/off

The Phoenix Smart IP43 Charger is equipped with remote on/off terminals, these terminals enable charging to be turned on or off remotely dependent on their state.

There are 3 options to turn the Phoenix Smart IP43 Charger on using the remote terminal(s):

1. Interconnect / short the L and H terminals (factory default is a shorting link between L and H). The L and H terminal can be interconnected /shorted via a switch, relay or other external device, like a battery management system (BMS).
2. Pull the H terminal to a high voltage level; when the voltage on the H terminal is above 2.9V (connected to battery positive for example) the charger will turn on. The H terminal can be connected to a high voltage level via a switch, relay or other external device, like a battery management system (BMS).
3. Pull the L terminal to a low voltage level; when the voltage on the L terminal is below 3.5V (connected to battery negative for example) the charger will turn off. The L terminal can be connected to a low voltage level via a switch, relay or other external device, like a battery management system (BMS).

To turn the Phoenix Smart IP43 Charger off using the remote terminal(s), both terminals need to have an open circuit relative to each other and be left floating (no connection to a high or low voltage level).

5.2.3. Programmable relay

The Phoenix Smart IP43 Charger is equipped with a programmable relay, the relay can be used for external control based on the selected relay mode (Alarm, Remote control, or Charging) and operational conditions.

There are 3 programmable relay terminals:

1. NO (Normally open)
2. C (Common)
3. NC (Normally closed)

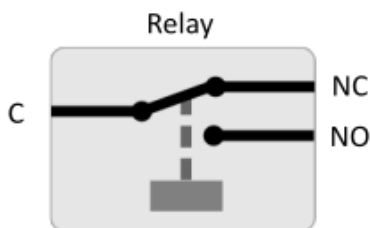

When the relay is switched off there is a closed circuit between C and NC, and an open circuit between C and NO.

When the relay is switched on there is a closed circuit between C and NO, and an open circuit between C and NC.

Wire the relay terminals to an external device as necessary in order to achieve the desired signal/control.



Note: The programmable relay function only works when AC input power is available and charging is enabled. If charging is disabled by any means (the remote on/off terminals, via VictronConnect or a GX device) the programmable relay functionally will also be disabled.

5.2.4. Schematics

1+1 output models

Refer to the wiring schematic below for the 1+1 output models:

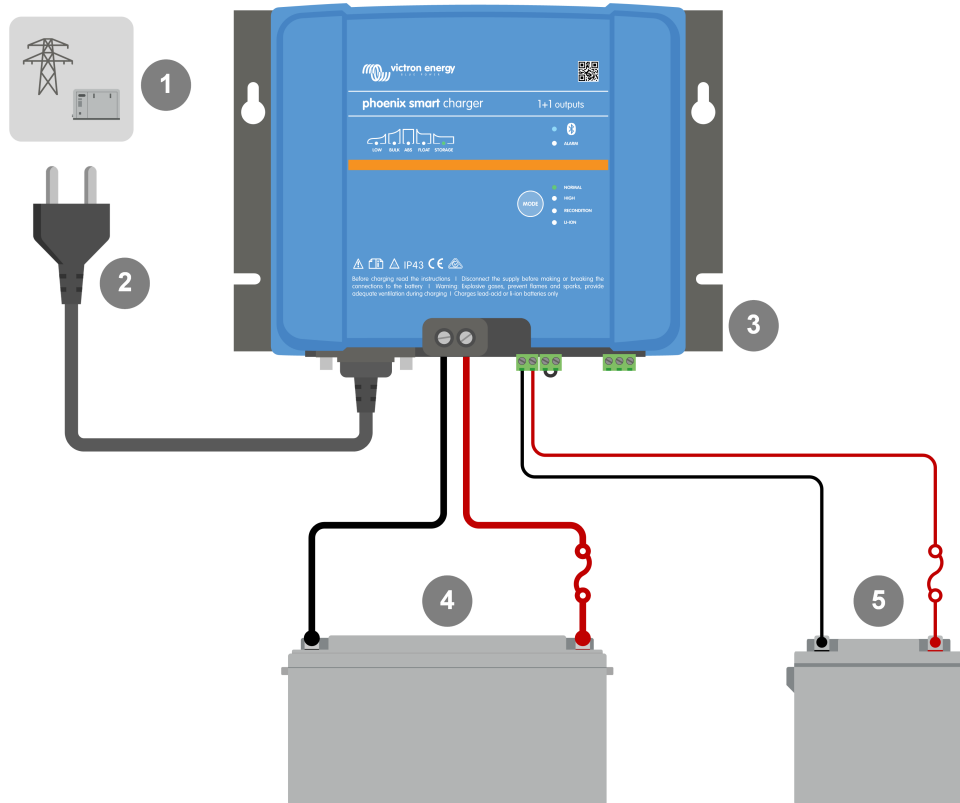

Key	Description
1	AC input power supply (typically mains power grid or generator)
2	AC input power supply cord/plug (purchased separately)
3	Phoenix Smart IP43 Charger
4	Main / house battery
5	Auxiliary / starter battery

3 output models

Refer to the wiring schematic below for the 3 output models:

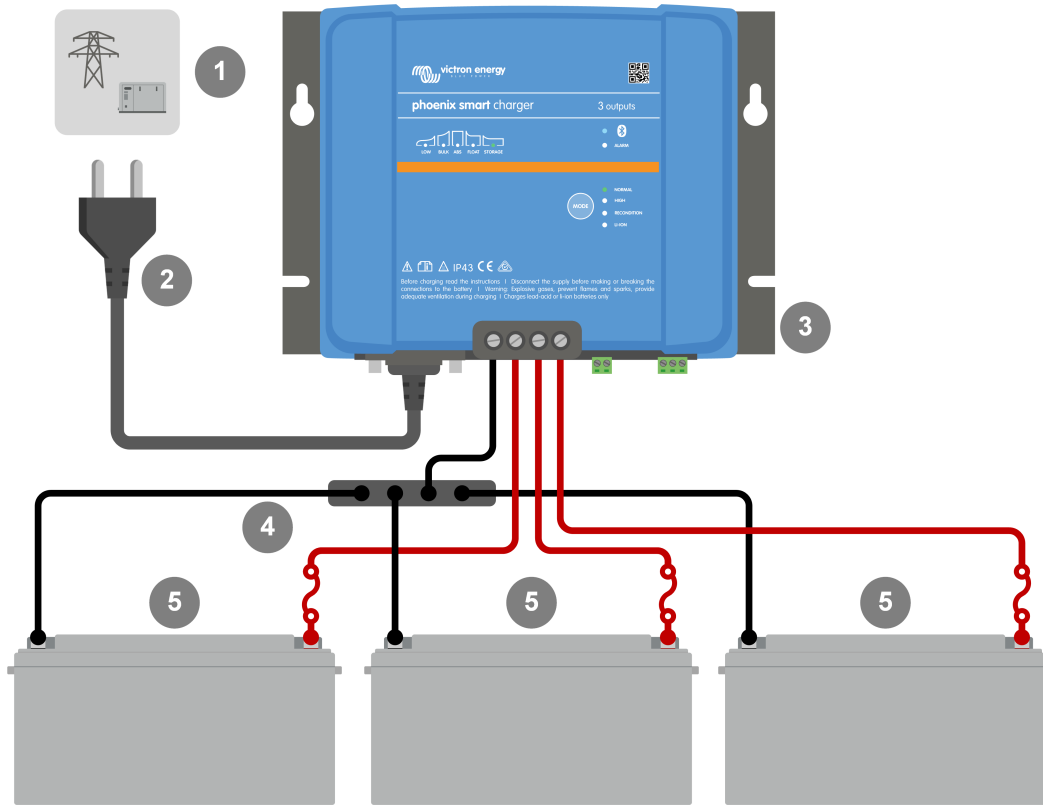

Key	Description
1	AC input power supply (typically mains power grid or generator)
2	AC input power supply cord/plug (purchased separately)
3	Phoenix Smart IP43 Charger
4	DC negative busbar
5	Batteries (1, 2 or 3 batteries can be connected)

VE.Smart Networking - Smart Battery Sense

Refer to the wiring schematic below for VE.Smart Networking with a Smart Battery Sense:

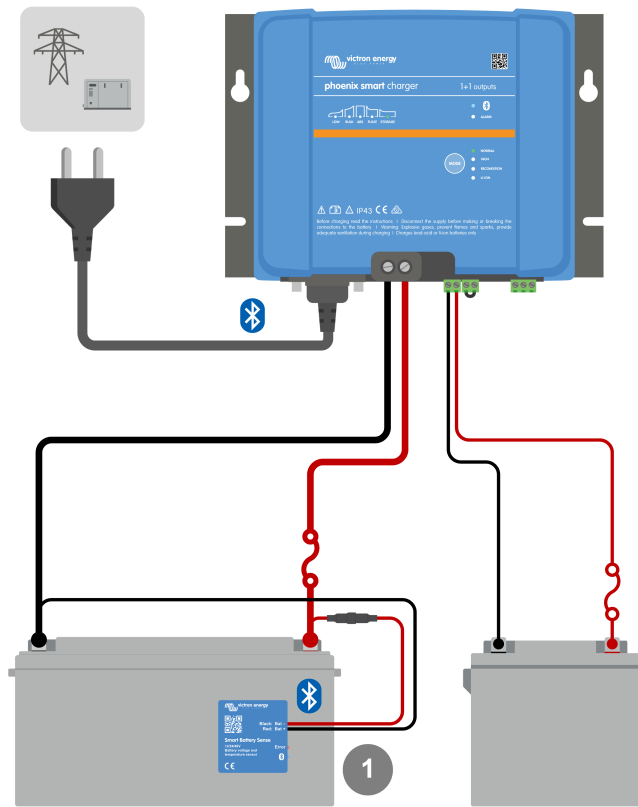

Key	Description
1	Smart Battery Sense

VE.Smart Networking - SmartShunt

Refer to the wiring schematic below for VE.Smart Networking with a SmartShunt or BMV:

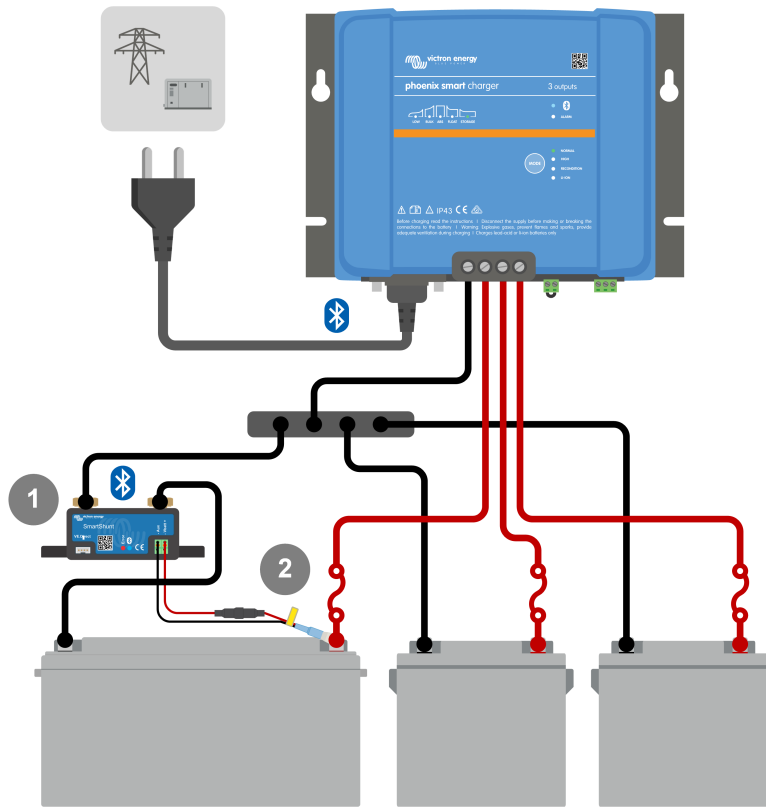

Key	Description
1	SmartShunt
2	Temperature sensor (with integrated voltage sense)

6. Setup

6.1. Charge modes

There are 3 integrated charge modes (Normal, High and Li-Ion), as well as an optional Recondition stage that can be included (except for Li-ion mode).

The integrated charge modes combined with adaptive charge logic are well suited for most common battery types; such as flooded lead-acid, AGM, Gel and LiFePO4.

The required charge mode can be selected via the MODE button or VictronConnect app - refer to the 'Settings - Using the MODE button' and 'Settings - Using VictronConnect' sections for more information.

If necessary, advanced configuration with user defined settings is possible using the VictronConnect app and a Bluetooth enabled device (such as a mobile phone or tablet) - refer to the 'Advanced Configuration' section for more information.

Any settings made are stored and will not be lost when the charger is disconnected from mains power or the battery.

6.1.1. Charge voltage

By simply selecting the integrated charge mode appropriate for the battery type being charged, (refer to the battery manufacturer's recommendations) the voltage settings for each charge stage will be altered according to the table below:

Mode	Absorption		Float		Storage		Recondition	
	12V	24V	12V	24V	12V	24V	12V	24V
Normal	14.4V	28.8V	13.8V	27.6V	13.2V	26.4V	Disabled	
Normal + Recondition	14.4V	28.8V	13.8V	27.6V	13.2V	26.4V	16.2V	32.4V
High	14.7V	29.4V	13.8V	27.6V	13.2V	26.4V	Disabled	
High + Recondition	14.7V	29.4V	13.8V	27.6V	13.2V	26.4V	16.5V	33.0V
Li-ion	14.2V	28.4V	Disabled		13.5V	27.0V	Disabled	



Temperature Compensation: Charge voltage is automatically compensated depending on ambient temperature (except for Li-ion mode or if manually disabled) - refer to the 'Operation - Temperature compensation' section for more information.

6.1.2. Recondition mode

If enabled the recondition stage is included in the charge cycle; use only if required as a corrective/maintenance action - refer to the 'Operation - Charge algorithm' section for more information.

When the recondition mode is enabled the RECONDITION LED will be illuminated and blink during recondition stage.

Recondition mode can be enabled and disabled via the MODE button or VictronConnect app - refer to the 'Settings - Using the MODE button' and 'Settings - Using VictronConnect' sections for more information.

6.1.3. Low current mode

If enabled the maximum charge current is limited to a significantly reduced level (varies per model - refer to 'Specification' section for more information) compared to the nominal maximum charge current.

Low current mode is recommended when charging lower capacity batteries with a high current charger; charging at an excessive charge current can cause premature battery degradation and overheating.

Typically the maximum charge current for lead acid batteries should not exceed ~0.3C (more than 30% of the battery capacity in Ah) and the maximum charge current for LiFePO4 batteries should exceed ~0.5C (more than 50% of the battery capacity in Ah).

When low current mode is enabled the LOW LED will blink.

Low current mode can be enabled and disabled via the MODE button or VictronConnect app - refer to the 'Settings - Using the MODE button' and 'Settings - Using VictronConnect' sections for more information.

6.2. Using the MODE button

Selection of an integrated charge mode and other general settings can be made using the physical MODE button on the charger.

To select an integrated charge mode using the MODE button:

1. Briefly press the MODE button to cycle through the available charge mode options; the LED beside the currently selected charge mode will be illuminated.

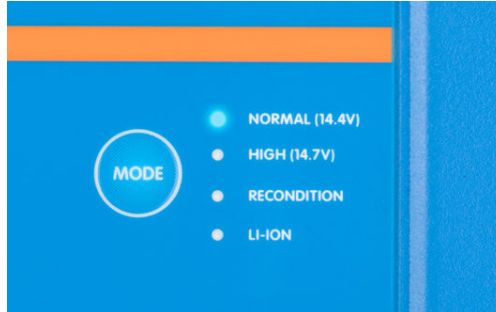

2. If required, activate recondition mode by continuing to cycle through the available options; when enabled the RECONDITION LED will be illuminated in addition to the selected charge mode LED.
3. If required, activate low current mode (reduced charge current) by pressing and holding the MODE button for 3 seconds; when enabled the LOW LED will blink.

To deactivate low current mode, also press and hold the MODE button for 3 seconds.

6.3. Using VictronConnect

Selection of an integrated charge mode and other general settings can also be made with a Bluetooth enabled device (such as a mobile phone or tablet), using the VictronConnect app.

For further details about the VictronConnect app refer to the online user manual: <https://www.victronenergy.com/live/victronconnect:start>

To select an integrated charge mode using VictronConnect:

- a. Download and install the VictronConnect app.

The VictronConnect app can be downloaded from the following locations:

- i. Android – Google Play Store
- ii. iOS/Mac – Apple App Store

- b. Enable Bluetooth on the mobile phone or tablet (if not already enabled).

- c. Open the VictronConnect app and look for the **Phoenix Smart IP43 Charger** in the 'LOCAL' page, if it doesn't automatically appear perform a manual scan for devices in range by selecting the 'scan' button (round orange button with circular arrow) in the bottom right corner.

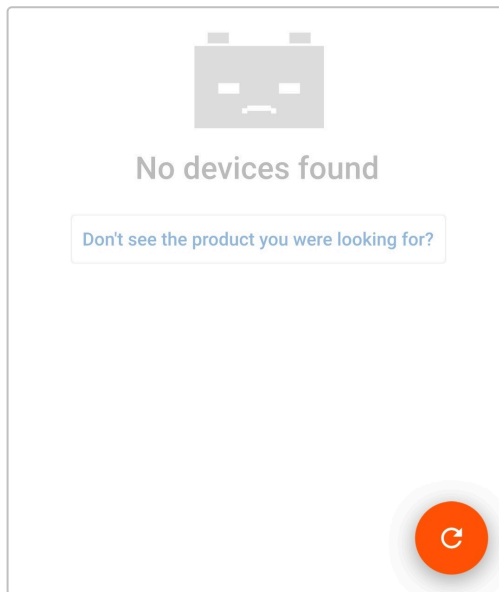

- d. Select the **Phoenix Smart IP43 Charger** from the 'LOCAL' device list.

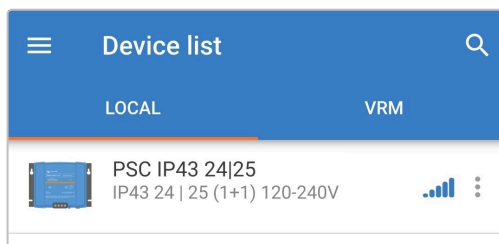

- e. During initial connection a 'Bluetooth pairing request' prompt will appear requesting the Bluetooth PIN code; enter the default PIN code 000000.

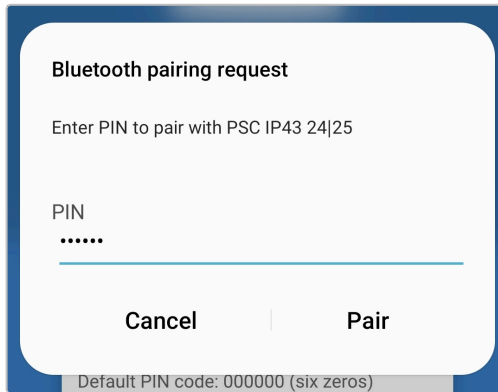

- f. Access the 'Settings' menu by selecting the 'Setting' icon (gear) in the top right corner.



- g. Access the 'Battery settings' menu by selecting the 'Battery settings' menu option.

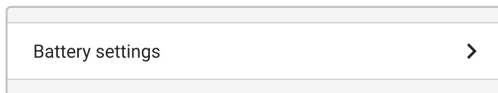

- h. Expand the 'Battery preset' drop-down menu, then select 'Built-in preset' or alternatively 'Select preset' for more specialised battery types.

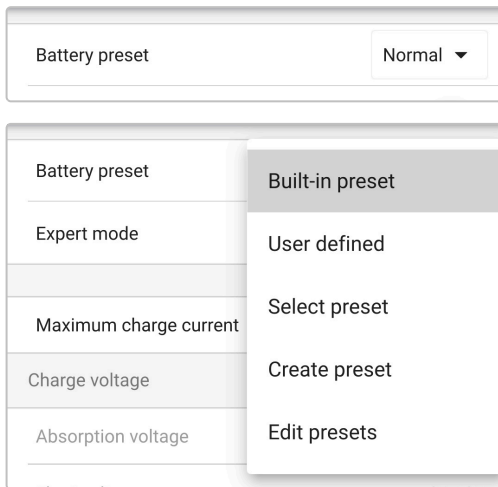

- i. Review the available options and select the most appropriate charge preset, then press 'OK'.

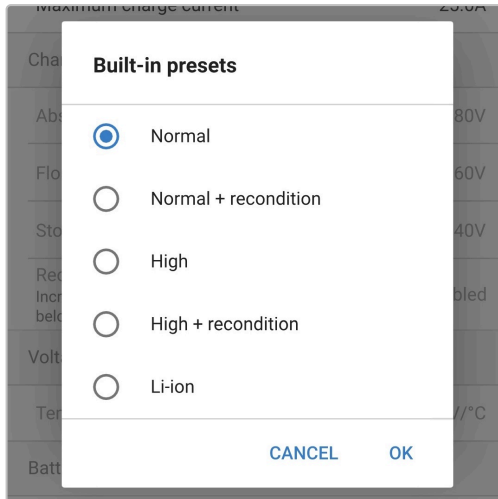

- j. If required, set a lower maximum charge current:
 - i. Access the 'Maximum charge current' menu by selecting the 'Maximum charge current' menu option.

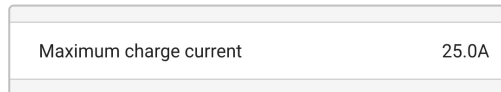

- ii. Review the available options and select the most appropriate maximum charge current preset (Minimum / Low / Maximum) or specify an alternative current (between the minimum and maximum limits) using the numeric input controls near the bottom.

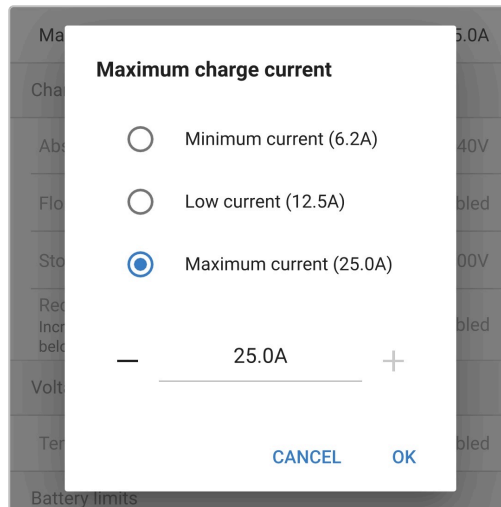

- k. Confirm that all the new settings and related charge voltages have been implemented correctly and are suitable. Illumination of the indicator LEDs on the **Phoenix Smart IP43 Charger** will also update according to the selected charge mode and settings implemented.

6.4. Bluetooth

6.4.1. Changing the PIN code

To prevent an unauthorised Bluetooth connection, it is highly recommended to change the default PIN code.

To change the Bluetooth PIN code:

- Complete initial Bluetooth pairing and connection using the default PIN code (000000)
- Access the 'device options' by selecting the 'settings' icon (gear) in the top right corner, then the 'device options' icon (three vertical dots).

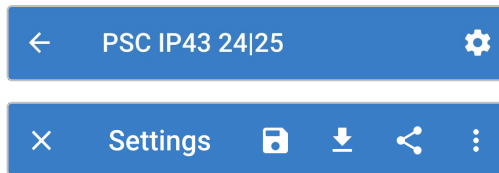

- Open the 'Product info' page by selecting 'Product info'.

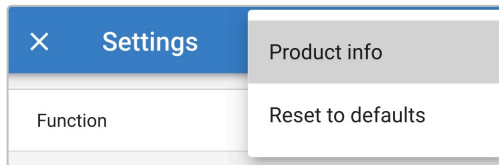

- Beside 'Pin code' select 'CHANGE' to open the 'Change PIN code' window.

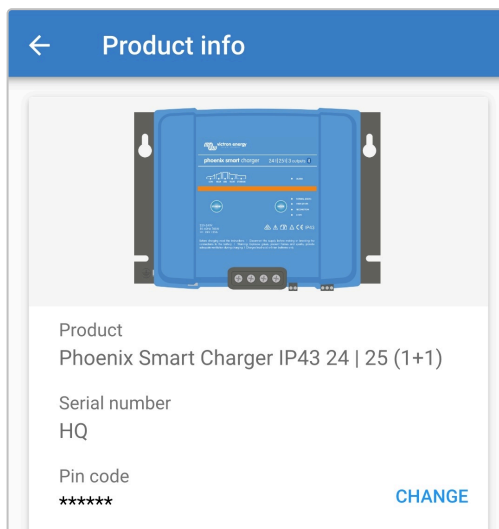

- e. Enter the current and new PIN code (twice), then select OK; avoid using an obvious PIN code that is easy for someone else to guess, such as 111111 or 123456.

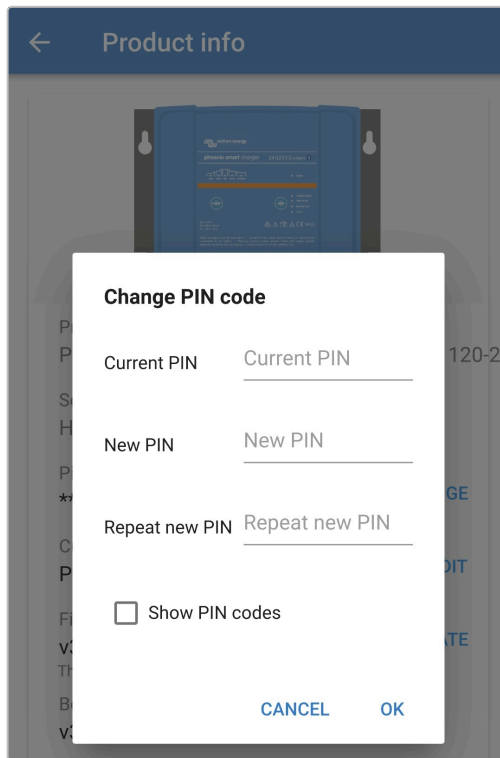

6.4.2. Resetting the PIN code

If the PIN code is forgotten or lost, it can be easily reset to the default 000000 using the VictronConnect app.

Using VictronConnect

To reset the Bluetooth PIN code:

1. Locate the blue smart charger in the LOCAL page and select the 'device options' icon (three vertical dots) on the right side of the description.

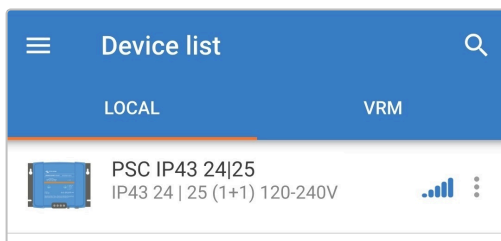

2. Select 'Reset PIN code' from the pop-up prompt.

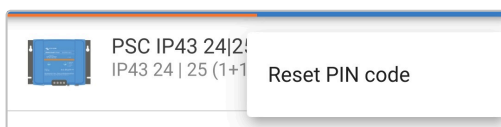

3. Enter the PUK code and select 'OK'. The PUK code is located on a label stuck to the side of the **Phoenix Smart IP43 Charger**.

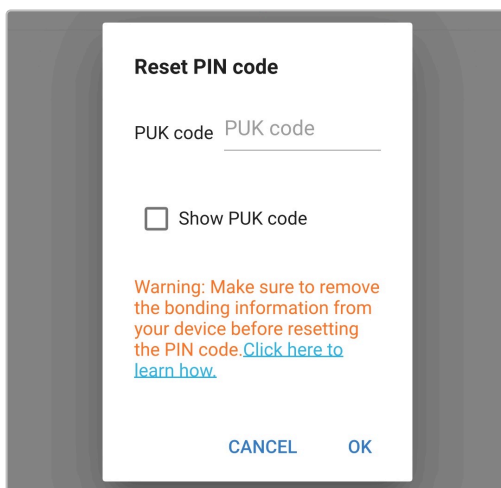

Using the MODE button

To reset the Bluetooth PIN code:

1. Depress and hold the MODE button (on the **Phoenix Smart IP43 Charger**) for 10 seconds.
2. After 10 seconds have elapsed all charge mode LEDs will blink twice to indicate that the PIN code has been reset.



During this procedure:

- a. The PIN code is reset to default (000000)
- b. Any active Bluetooth connections are disconnected
- c. All Bluetooth pairing information is cleared

Subsequently, before attempting to re-connect it's also necessary to remove/clear the Phoenix Smart IP43 Charger Bluetooth pairing information from any devices (mobile phones or tablets) that were previously paired.

6.4.3. Disabling Bluetooth

It is possible to totally disable Bluetooth communication if desired.

Typically, there is no need to disable Bluetooth since unauthorised access is protected with a PIN code, but certain situations may warrant it for an even higher level of security.

To disable Bluetooth:

- a. Complete initial Bluetooth pairing and connection using the default PIN code (000000) or the current PIN code set.
- b. Access the 'device options' by selecting the 'settings' icon (gear) in the top right corner, then the 'device options' icon (three vertical dots).

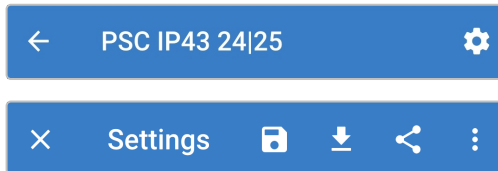

- c. Open the 'Product info' page by selecting 'Product info'.

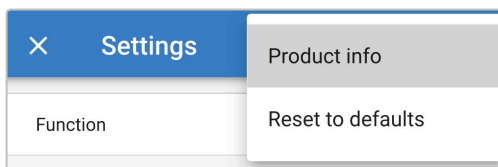

- d. Beside 'Bluetooth Enabled' select 'DISABLE' to open the 'Disable Bluetooth' window.

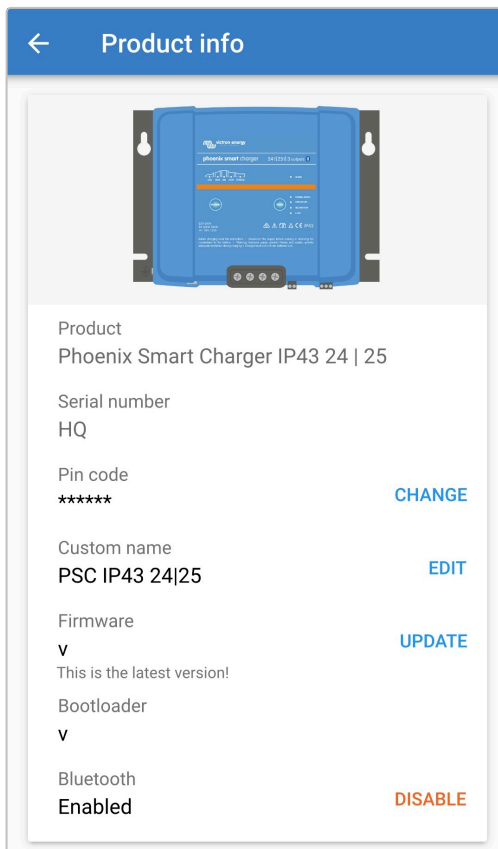

- e. Tick the checkbox and then select 'OK' as confirmation.

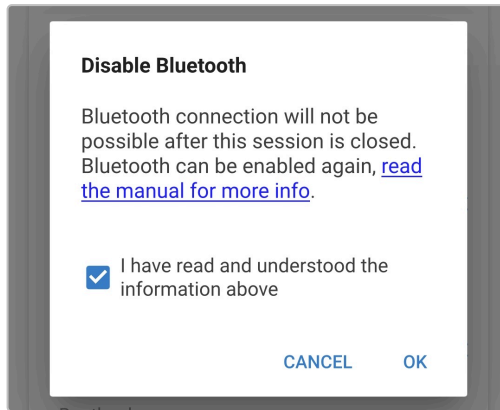

- f. Bluetooth will now be disabled, but can be re-enabled again.

6.4.4. Re-enabling Bluetooth

It is possible to re-enable Bluetooth using the MODE button.

To re-enable Bluetooth:

- a. Depress and hold the MODE button (on the **Phoenix Smart IP43 Charger**) for 10 seconds.



- b. After 10 seconds have elapsed all charge mode LEDs will blink twice to indicate that Bluetooth has been re-enabled, and all Bluetooth settings reset.



During this procedure:

- a. Bluetooth is re-enabled
- b. The PIN code is reset to default (000000)
- c. Any active Bluetooth connections are disconnected
- d. All Bluetooth pairing information is cleared

Subsequently, before attempting to re-connect it's also necessary to remove/clear the Phoenix Smart IP43 Charger Bluetooth pairing information from any devices (mobile phones or tablets) that were previously paired.

6.5. VE.Smart Networking

VE.Smart Networking enables Bluetooth connectivity and communication between multiple Victron products to further enhance the charge cycle. Refer to the 'Operation - VE.Smart Networking' section for more information.

After VE.Smart networking compatible hardware is installed, VE.Smart networking needs to be setup/enabled.

6.5.1. Voltage, temperature and current sense

To setup a VE.Smart Network with Volt-Sense / Temp-Sense / Current-Sense:

1. Locate and select the battery monitor (BMV, SmartShunt, Smart Battery Sense or VE.Bus Smart Dongle) from the device list on the LOCAL page.

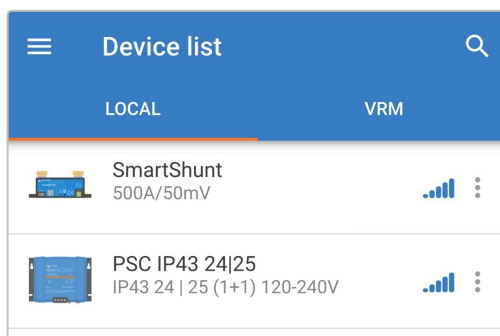

2. If prompted, complete initial Bluetooth pairing and connection; the default PIN code is 000000.

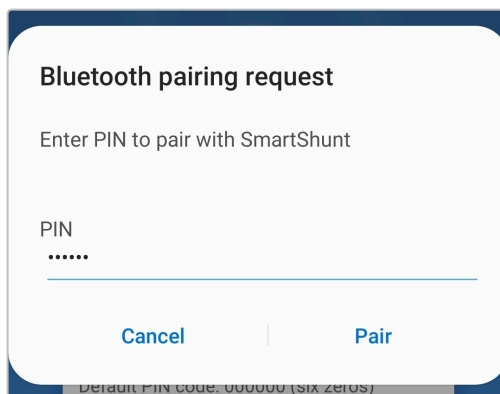

3. Access the settings menu by selecting the 'settings' icon (gear) in the top right corner.



4. Open the VE.Smart networking page by selecting 'VE.Smart networking'.



5. Select 'CREATE NETWORK' (or 'JOIN NETWORK' if the VE.Smart network has already been created).

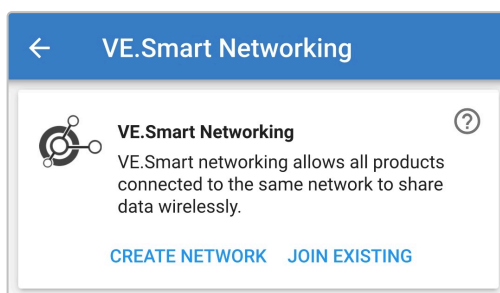

6. Enter a name to identify the VE.Smart network and select 'OK' to the prompts.

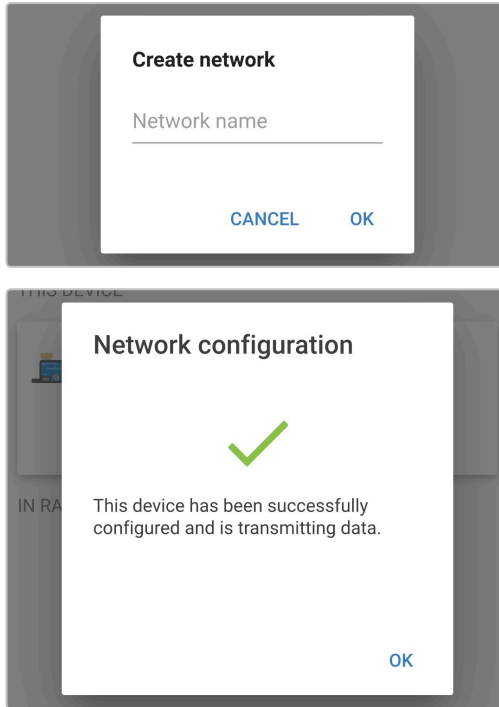

7. Once setup, details of the data being transmitted to the VE.Smart network are shown on the VE.Smart networking page.

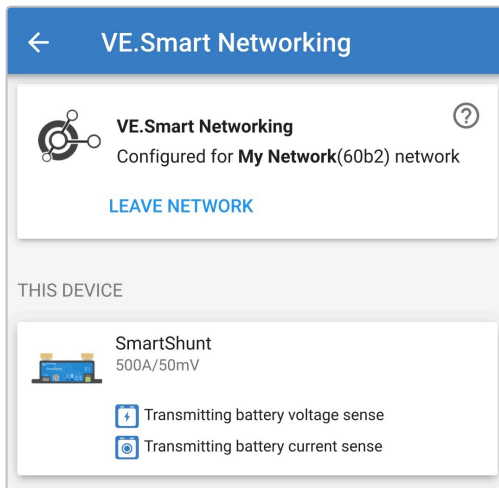

8. Exit the device by selecting the back 'arrow' icon and 'close' icon (cross) in the top left corner.
9. Locate and select the Phoenix Smart IP43 Charger from the device list on the LOCAL page.

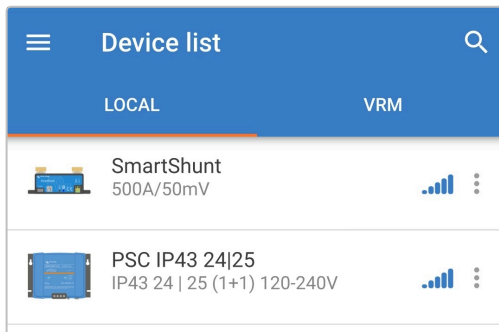

10. If prompted, complete initial Bluetooth pairing and connection; the default PIN code is 000000.

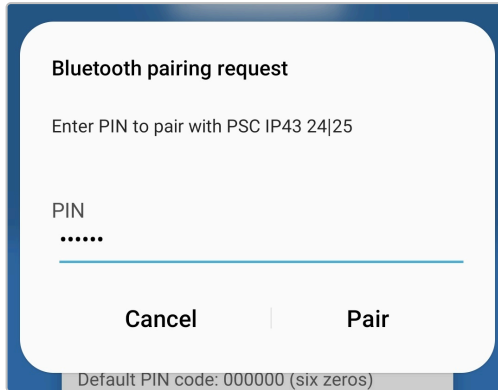

11. Access the 'settings' menu by selecting the 'settings' icon (gear) in the top right corner.



12. Open the 'VE.Smart networking' page by selecting 'VE.Smart networking'.

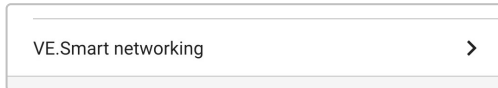

13. Select 'JOIN EXISTING'.

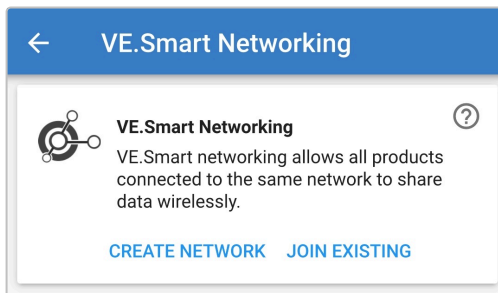

14. Locate and select the VE.Smart network previously setup (or the network you want to join if there are multiple), then select 'OK' to the prompts.

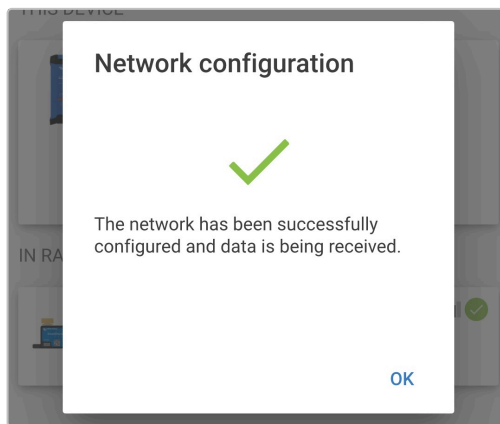
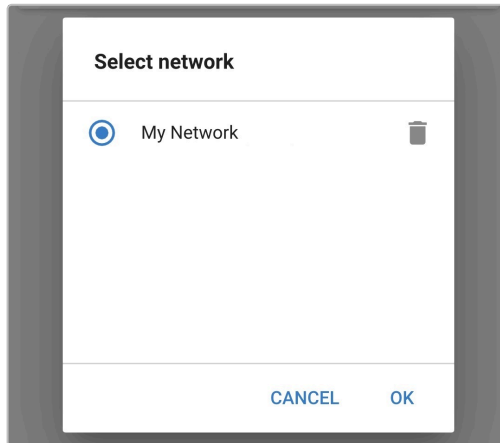

15. The VE.Smart network is now configured, details of the data being received from the VE.Smart network are shown on the VE.Smart network page.

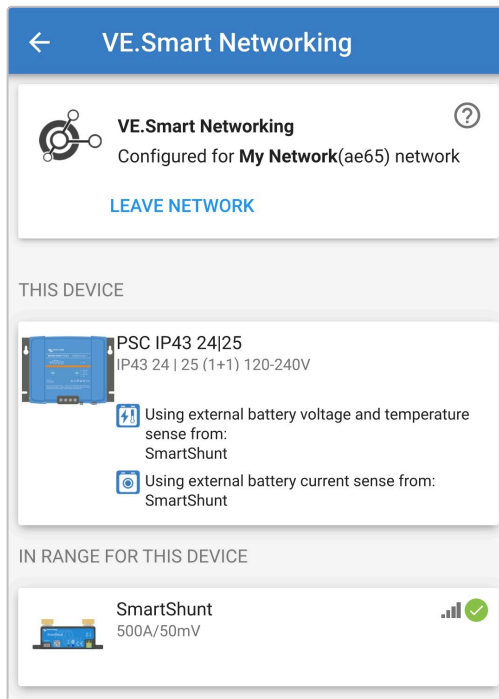

Once successfully configured:

- a. The VE.Smart network symbol will appear in the top right corner of the STATUS screen (both the battery monitor and the charger).

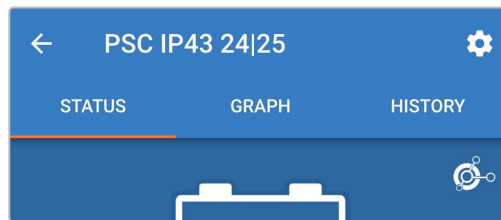

- b. The charge state LED on the charger (bulk / absorption / float / storage) will blink every 4 seconds.

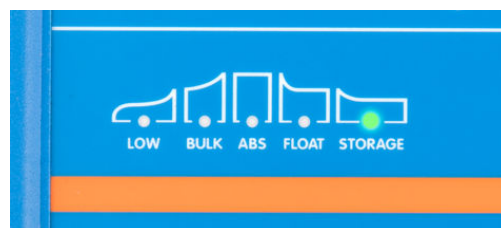

16. For systems with multiple compatible chargers, repeat the relevant steps above for each additional charger.

- 1. Only one battery monitor (BMV, SmartShunt, Smart Battery Sense or VE.Bus Smart Dongle) can be included in a VE.Smart network.
- 2. All battery monitor connections (voltage sensing cables, temperature sensor and current shunt) and chargers in a common VE. Smart network must be connected to the same battery / battery bank.
- 3. The maximum number of devices permitted in a VE.Smart network is 10.
- 4. Communication via VE.Smart networking requires all devices to be located within Bluetooth range of each other. Systems with poor or intermittent Bluetooth signal between devices will experience connection issues. Signal strength between devices can be checked in the VictronConnect VE.Smart networking page.
- 5. Multiple chargers in a common VE.Smart network must have the same charge settings, since the 'master' can change dynamically any charger could become the 'master'.
- 6. Multiple chargers in a common VE.Smart network do not need to be the same model, they just need to be VE.Smart Networking compatible (this includes VE.Smart Networking compatible Blue Smart chargers, Phoenix chargers and MPPT solar chargers).
- 7. Some older devices are not VE.Smart networking compatible, refer to the product manual for confirmation.

6.5.2. Synchronised charging

To setup a VE.Smart Network with Synchronised charging:

- Locate and select the Phoenix Smart IP43 Charger from the device list on the LOCAL page.

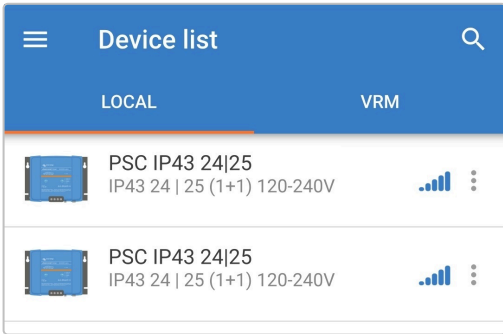

- If prompted, complete initial Bluetooth pairing and connection; the default PIN code is 000000.

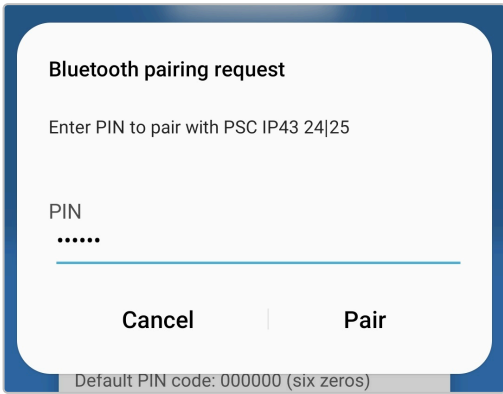

- Access the 'settings' menu by selecting the 'settings' icon (gear) in the top right corner.



- Open the VE.Smart networking page by selecting 'VE.Smart networking'.

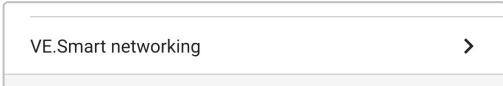

5. Select 'CREATE NETWORK' (or 'JOIN NETWORK' if the VE.Smart network has already been created).

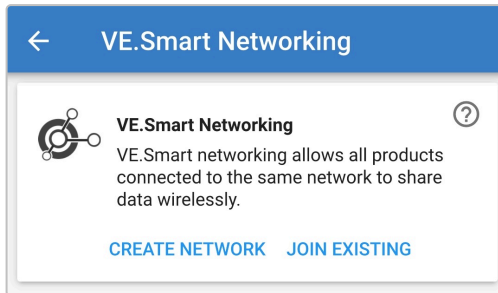

6. Enter a name to identify the VE.Smart network and select 'OK' to the prompts.

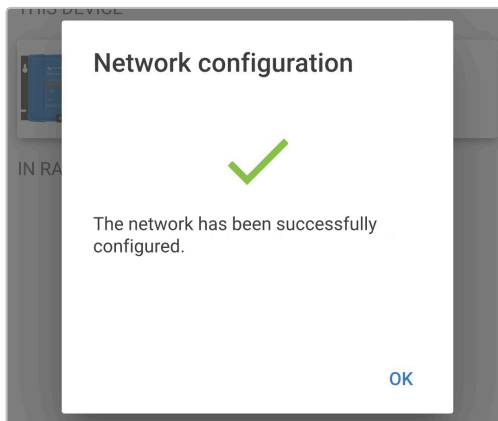
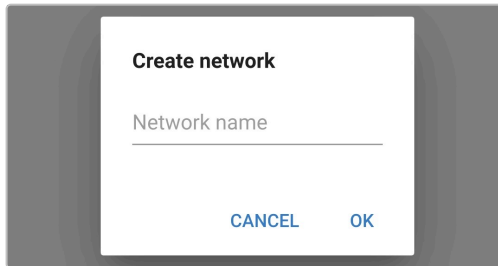

7. Once setup, details of the data being transmitted to the VE.Smart network are shown on the VE.Smart networking page.

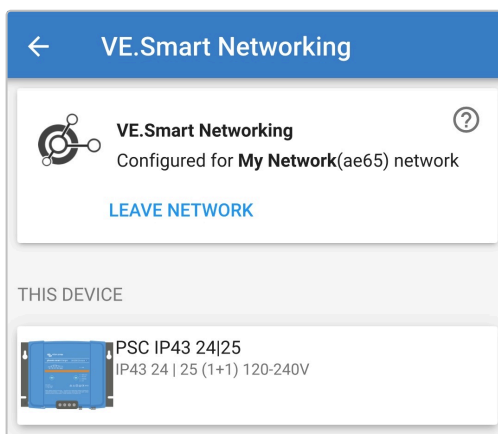

8. Exit the device by selecting the back 'arrow' icon and 'close' icon (cross) in the top left corner.

9. Locate and select another VE.Smart Networking compatible charger from the device list on the LOCAL page.

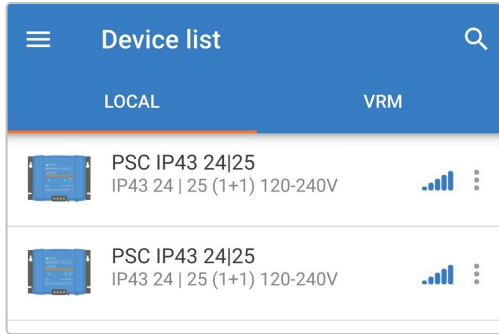

10. If prompted, complete initial Bluetooth pairing and connection; the default PIN code is 000000.

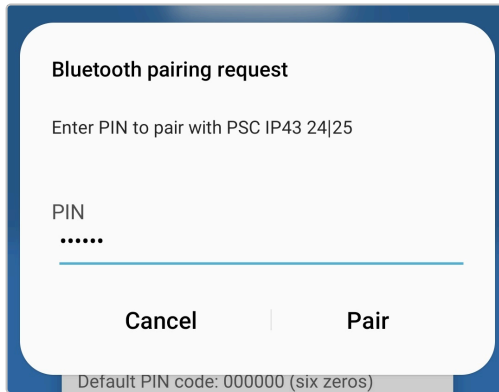

11. Access the settings menu by selecting the 'settings' icon (gear) in the top right corner.



12. Open the 'VE.Smart networking' page by selecting 'VE.Smart networking'.

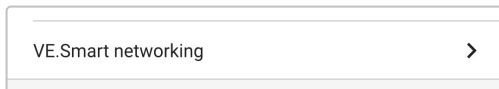

13. Select 'JOIN EXISTING'.

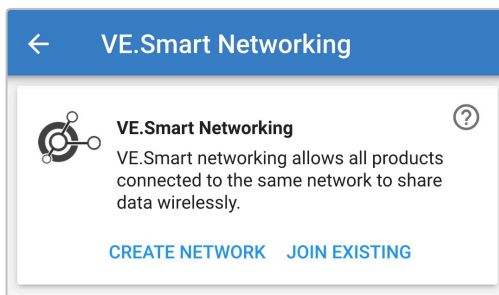

14. Locate and select the VE.Smart network previously setup (or the network you want to join if there are multiple), then select 'OK' to the prompts.

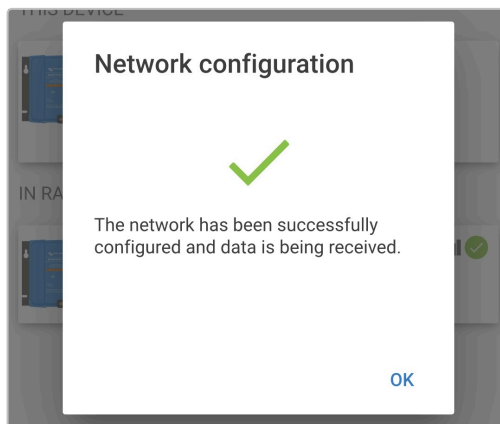
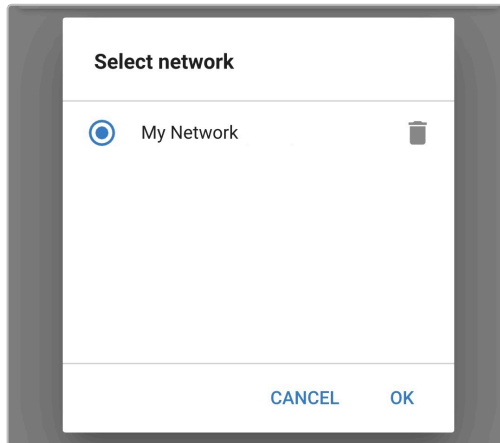

15. The VE.Smart network is now configured, details of the synchronised chargers in the VE.Smart network are shown on the VE.Smart network page.

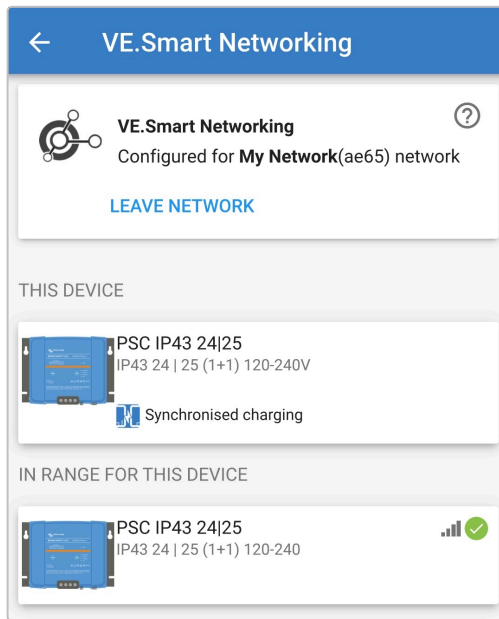

Once successfully configured:

- a. The VE.Smart network symbol will appear in the top right corner of the STATUS screen (of each charger in the network).

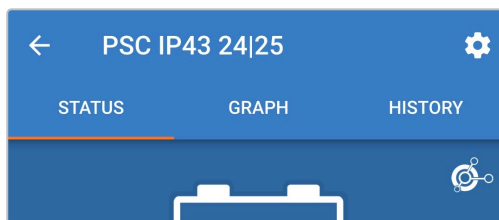

- b. The charge state LED on the charger (bulk / absorption / float / storage) will blink every 4 seconds.

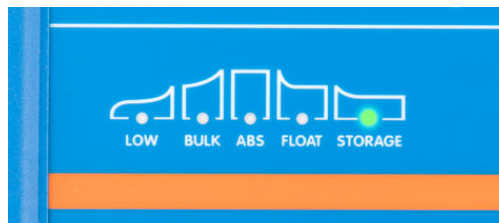

16. For systems with multiple compatible chargers, repeat the relevant steps above for each additional charger.



1. Only one battery monitor (BMV, SmartShunt, Smart Battery Sense or VE.Bus Smart Dongle) can be included in a VE.Smart network.
2. All battery monitor connections (voltage sensing cables, temperature sensor and current shunt) and chargers in a common VE. Smart network must be connected to the same battery / battery bank.
3. The maximum number of devices permitted in a VE.Smart network is 10.
4. Communication via VE.Smart networking requires all devices to be located within Bluetooth range of each other. Systems with poor or intermittent Bluetooth signal between devices will experience connection issues. Signal strength between devices can be checked in the VictronConnect VE.Smart networking page.
5. Multiple chargers in a common VE.Smart network must have the same charge settings, since the 'master' can change dynamically any charger could become the 'master'.
6. Multiple chargers in a common VE.Smart network do not need to be the same model, they just need to be VE.Smart Networking compatible (this includes VE.Smart Networking compatible Blue Smart chargers, Phoenix chargers and MPPT solar chargers).
7. Some older devices are not VE.Smart networking compatible, refer to the product manual for confirmation.

6.6. System reset

It is possible to perform a full system reset to restore all charger/battery related settings to their default value; using the VictronConnect app.

Note that this does **not** reset any Bluetooth related settings, such as the PIN code or pairing information.

To perform a system reset:

- Complete initial Bluetooth pairing and connection using the default PIN code (000000).
- Access the 'device options' by selecting the 'settings' icon (gear) in the top right corner, then the 'device options' icon (three vertical dots).

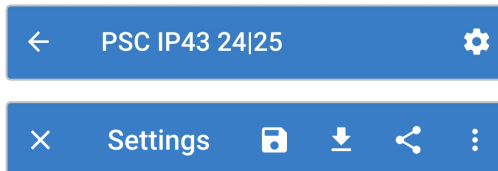

- Open the 'restore device' page by selecting 'Reset to defaults'.

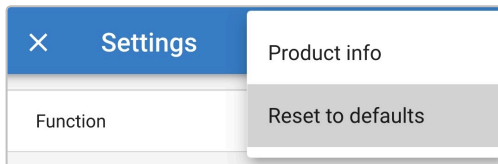

- Select 'YES' to reset all settings to factory defaults.

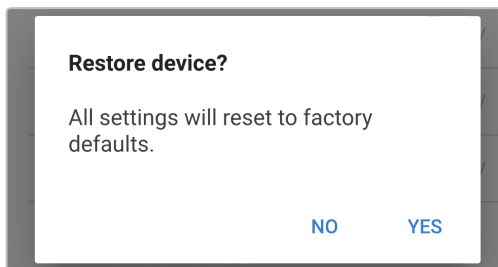

7. Monitoring

7.1. LED indications

7.1.1. Operation states

The Phoenix Smart IP43 Charger has multiple LEDs that can be referenced to determine the current charge state and other operational information.

Refer to the LED indications in the table below:

Charge state	LOW	BULK	ABS	FLOAT	STORAGE	ALARM
Charging disabled	Off	Blinking	Off	Off	Off	Off
Bulk	Off	Illuminated	Off	Off	Off	Off
Absorption	Off	Off	Illuminated	Off	Off	Off
Recondition	Off	Blinking	Blinking	Off	Off	Off
Float	Off	Off	Off	Illuminated	Off	Off
Storage	Off	Off	Off	Off	Illuminated	Off
Low current mode	Illuminated	N/A	N/A	N/A	N/A	N/A

7.1.2. Error states

If an error occurs, the red ALARM LED will illuminate, the charge state LEDs can then be referenced to determine the specific error state.

Refer to the LED indications in the table below:

Error state	LOW	BULK	ABS	FLOAT	STORAGE	ALARM
Bulk time protection	Off	Blinking	Off	Off	Off	Illuminated
Internal Error*	Off	Blinking	Blinking	Blinking	Off	Illuminated
Charger over-voltage	Off	Off	Blinking	Off	Blinking	Illuminated
Charger over-current	Off	Blinking	Off	Off	Blinking	Illuminated
Low mains voltage	Blinking	Off	Off	Off	Off	Illuminated
BMS connection lost	Off	Off	Off	Blink	Blink	Illuminated

* Note that warning #31 (Input voltage measurement out of range) uses the same LED blinking code. The difference is that on warning #31 the device continues to work.

7.2. VictronConnect

The charger operation and recharge statistics can be closely monitored live or post charging with a Bluetooth enabled device (such as a mobile phone or tablet) using the VictronConnect app.

There are 3 different overview screens available (STATUS, GRAPH and HISTORY), each displaying different monitoring or historical data; spanning back over the last 40 charge cycles.

The desired screen can be selected by either selecting the window title or by swiping across between screens.

7.2.1. Status screen

The STATUS screen is the main overview screen; it displays the battery voltage, the charge current and the active charge stage.

This data will update continuously and in real time as the charge cycle progresses.

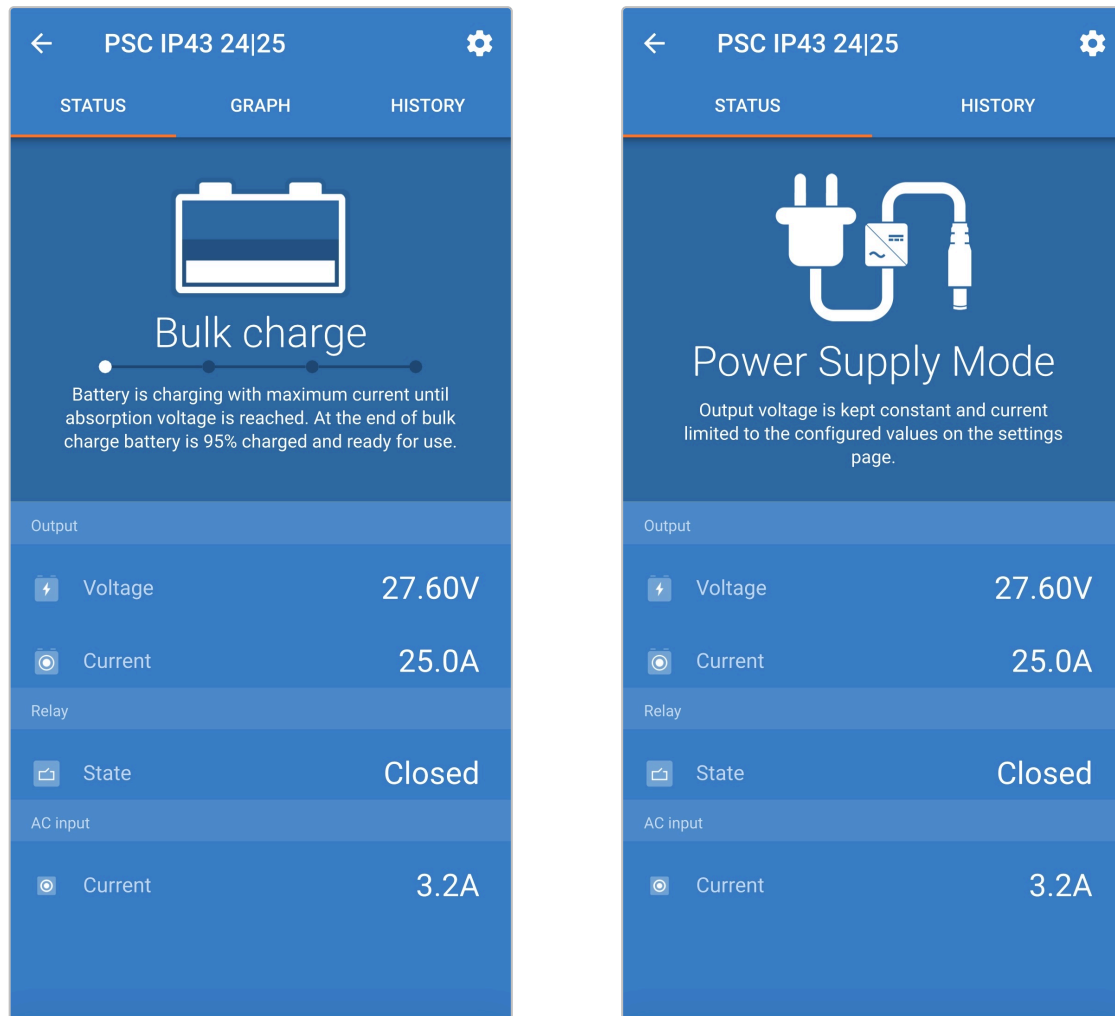

7.2.2. Graph screen

The GRAPH screen provides an easy to understand graphical representation of each charge stage with respect to battery voltage and charge current.

The active charge stage is also highlighted and stated below, along with a brief explanation.

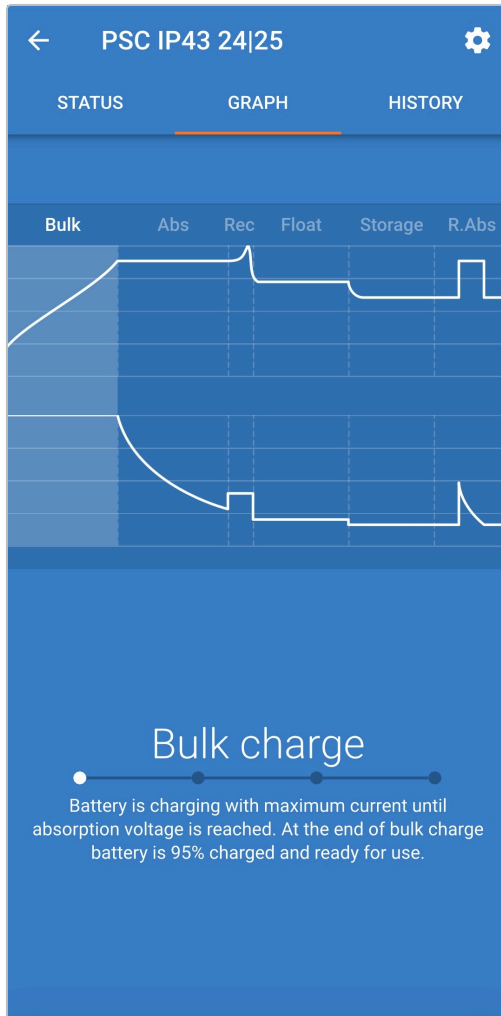

7.2.3. History screen

The HISTORY screen is a very powerful reference as it contains historical usage data over the charger's lifetime and detailed statistics for the last 40 charge cycles (even if the charge cycle is only partially completed).

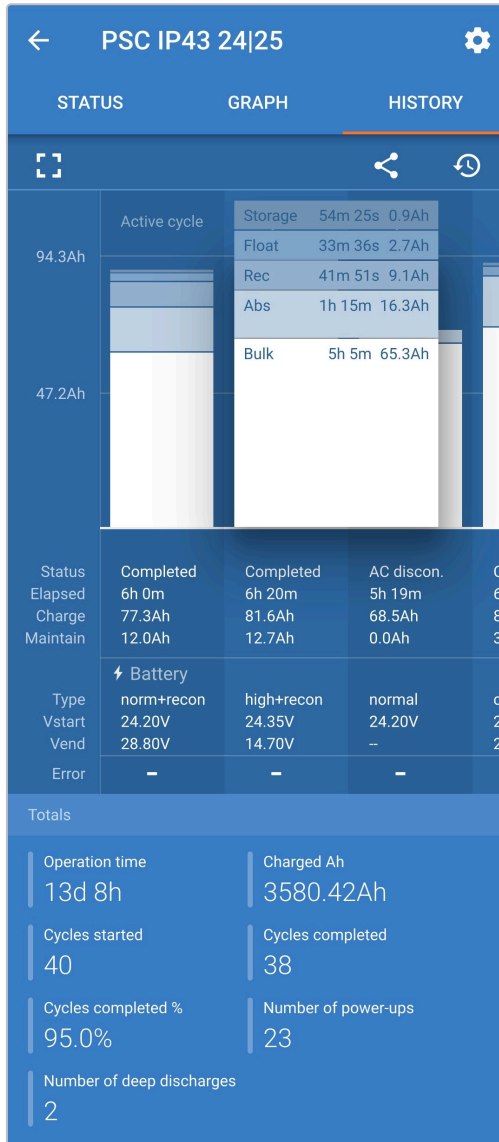

By selecting the full screen view the data is displayed in landscape view with significantly more days visible at the same time.

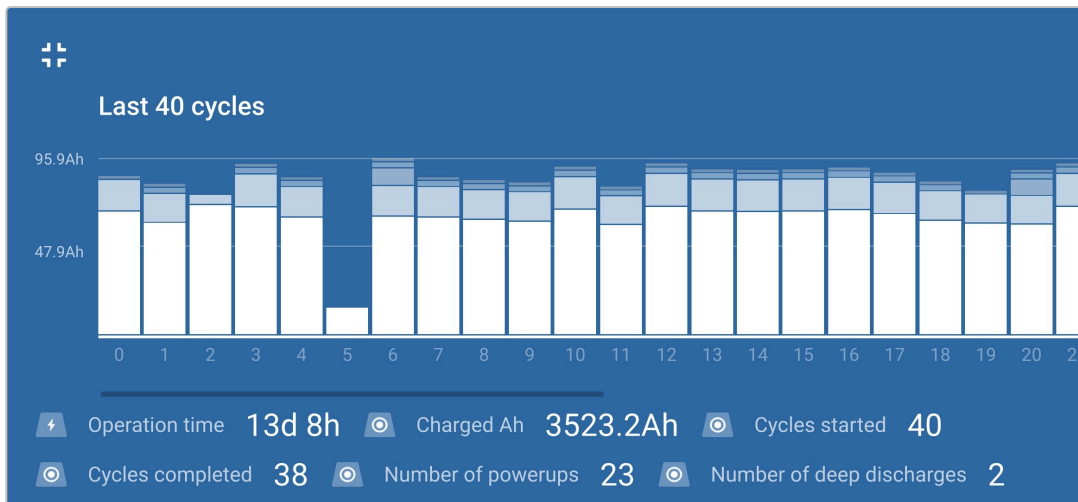

a. **Charge cycle statistics**

i. **Cycle overview**

Expandable bar chart showing the time spent in each charge stage and the charge capacity provided (in Ah) during each charge stage

ii. **Status**

Confirms if the charge cycle was successfully completed or if it was ended early/interrupted for some reason, including the reason/cause

iii. **Elapsed**

The elapsed/total charge cycle time

iv. **Charge**

Total capacity provided during the recharge stages (Bulk and Absorption)

v. **Maintain**

Total capacity provided during the charge maintenance stages (Float, Storage and Refresh)

vi. **Type**

The charge cycle mode used; either a 'Built-in preset' or a custom 'Userdefined' configuration

vii. **Vstart**

Battery voltage when charging commences

viii. **Vend**

Battery voltage when charging is complete (end of absorption stage)

ix. **Error**

Displays if any errors occurred during the charge cycle, including the error number and description

b. **Charger lifetime statistics**

i. **Operation time**

The total operation time over the lifetime of the charger

ii. **Charged Ah**

The total charge capacity provided over the lifetime of the charger

iii. **Cycles started**

The total charge cycles started over the lifetime of the charger

iv. **Cycles completed**

The total charge cycles completed over the lifetime of the charger

v. **Cycles completed %**

The percentage of charge cycles completed over the lifetime of the charger

vi. **Number of power-ups**

The number of times the charger has been powered up over the lifetime of the charger

vii. **Number of deep discharges**

The number of times the charger has recharged a deeply discharged battery over the lifetime of the charger

8. Advanced Configuration

In specific use cases where the integrated charge modes are not suitable/ideal for the battery type being charged or the battery manufacturer recommends specific charge parameters and fine tuning is desired, advanced configuration is possible with a Bluetooth enabled device (such as a mobile phone or tablet) using the VictronConnect app.

For most common battery types, advanced configuration is not required or recommended; the integrated charge modes and adaptive charge logic are typically suitable and perform very well.

8.1. Advanced settings

The advanced settings menu enables specific configuration of charge parameters and user defined settings to be saved and easily loaded.

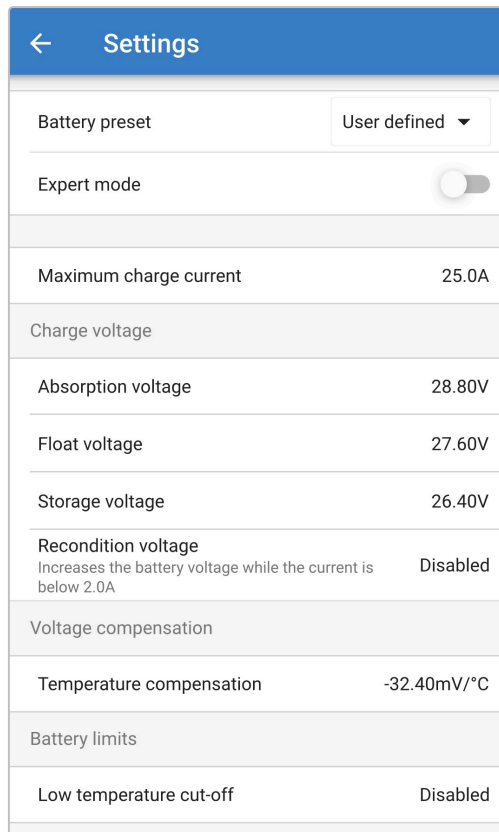

Settings	
Battery preset	User defined ▾
Expert mode	<input type="checkbox"/>
Maximum charge current	25.0A
Charge voltage	
Absorption voltage	28.80V
Float voltage	27.60V
Storage voltage	26.40V
Recondition voltage	Disabled
<small>Increases the battery voltage while the current is below 2.0A</small>	
Voltage compensation	
Temperature compensation	-32.40mV/°C
Battery limits	
Low temperature cut-off	Disabled

To access the 'advanced settings' menu:

- Access the 'settings' menu by selecting the 'settings' icon (gear) in the top right corner.



- Access the 'Battery settings' menu by selecting the 'Battery settings' menu option.

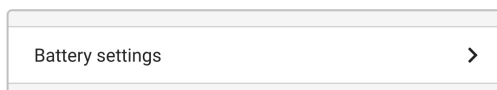

In order to edit/configure 'advanced settings':

- a. Select the 'Battery preset' dropdown arrow to expand the menu, then select 'User defined'.

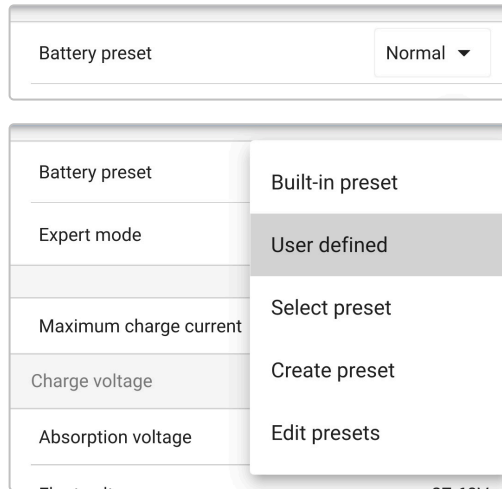

- b. 'User defined' configuration will now be enabled.

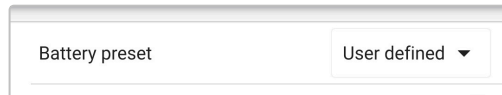
**The settings in the 'advanced menu' (with 'expert mode' disabled) include:**

a. **Maximum charge current**

The maximum charge current setting allows selection between the default and a significantly reduced charge current limit preset; Maximum, Low or Minimum current (current limits vary per model - refer to the 'Specifications' section for more information). Alternatively a user defined maximum charge current (between the minimum and maximum limits) can be configured.

b. **Battery preset**

The 'Battery preset' dropdown allows selection from the following options:

i. **Built-in preset**

Selection of a standard integrated pre-set (same as the general settings menu)

ii. **User defined**

Reselection of the last 'user defined' charge settings

iii. **Select preset**

Selection from an extended range of integrated battery charging pre-sets, including new user defined charging pre-sets

iv. **Create preset**

A new charging preset to be created and saved from user defined settings

v. **Edit presets**

An existing preset to be edited and saved

c. **Charge voltage**

The charge voltage settings enable the voltage setpoint for each charge stage to be independently configured and some charge stages (recondition and float) to be disabled or enabled.

The charge voltage setpoint for the following charge stages can be configured:

i. **Absorption**

ii. **Float**

iii. **Storage**

iv. **Recondition**

d. **Voltage compensation**

i. **Temperature Compensation**

The temperature compensation setting enables the charge voltage temperature compensation coefficient to be configured, or temperature compensation to be totally disabled (such as for Li-ion batteries). The temperature compensation coefficient is specified in mV/°C and applies to the entire battery/battery bank (not per battery cell).

e. **Battery limits**

i. **Low temperature cut-off**

The low temperature cut-off setting disables charging in low temperature conditions to protect Lithium batteries from damage; this setting requires battery temperature to be provided by a compatible device via the VE.Smart network.

8.2. Expert mode settings

Expert mode expands the advanced settings menu even further to include more specialised configuration settings.

Settings	
Battery preset	User defined ▼
Expert mode	<input checked="" type="checkbox"/>
Maximum charge current	25.0A
Charge voltage	
Absorption voltage	28.80V
Float voltage	27.60V
Storage voltage	26.40V
Recondition voltage <small>Increases the battery voltage while the current is below 2.0A</small>	Disabled
BatterySafe <small>Prevent excessive gassing by automatically limiting the rate of voltage increase.</small>	<input checked="" type="checkbox"/>
Voltage compensation	
Temperature compensation	-32.40mV/°C
Bulk	
Bulk time limit	10h 0m
Re-bulk voltage offset	0.20V
Absorption	
Absorption duration	Adaptive
Maximum absorption time	8h 0m
Tail current	Disabled
Repeated absorption	Every 7 days
Recondition	
Recondition current percentage	8%
Recondition stop mode	Automatic, on voltage ▼
Maximum recondition duration	1h 0m
Battery limits	
Low temperature cut-off	Disabled

To access the 'expert mode' menu:

- a. Open the 'advanced setting' menu and enable 'user defined' configuration - see the 'Advanced configuration - Advanced settings' section for instructions.
- b. Enable the 'Expert mode' switch, then select 'OK'.

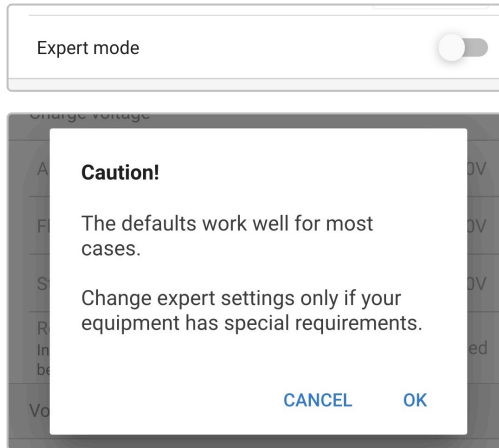

- c. The 'Expert mode' menu (extension of the 'advanced settings' menu) will now be enabled.

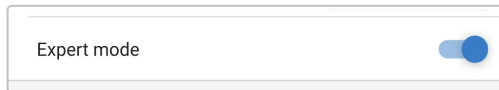

The ADDITIONAL settings in the 'advanced menu' with 'expert mode' enabled include:

- a. **Charge voltage**
 - i. **BatterySafe**

The BatterySafe setting allows the BatterySafe voltage control to be enabled or disabled. When BatterySafe is enabled, the rate of battery voltage increase during bulk stage is automatically restricted to a safe level. In cases where the battery voltage would otherwise increase at a faster rate, the charge current is consequently reduced to prevent excessive gassing.
- b. **Bulk**
 - i. **Bulk time limit**

The bulk time limit setting restricts the maximum time the charger can spend in bulk stage as a protection measure, since the absorption voltage should have been achieved by this time. If the bulk time limit is satisfied the charger will move directly to float stage.
 - ii. **Re-bulk voltage offset**

The re-bulk voltage offset setting is used to determine the re-bulk voltage threshold that will trigger a new charge cycle; the offset is relative to the configured 'Storage voltage' (re-bulk voltage = storage voltage - re-bulk voltage offset). If the battery voltage falls below re-bulk voltage threshold while the charger is in float or storage stage and remains below it for one minute, the charger will move back into bulk charge stage.

Note that even when the re-bulk setting is disabled, re-bulk will still occur if the charge current is maintained at the maximum charge current for 4 seconds while the charger is in float or storage stage.

c. **Absorption**

i. **Adaptive duration**

The adaptive duration setting allows selection between adaptive absorption time (calculated based on the bulk time / level of discharge) or a fixed absorption time.

ii. **Maximum absorption time / Absorption time**

The maximum absorption time / absorption time setting enables the maximum adaptive absorption time or the fixed absorption time to be configured (depending if adaptive or fixed absorption time is selected). Note that regardless if adaptive or fixed absorption time is selected, the absorption phase can end early based on the tail current setting (if enabled).

iii. **Tail current**

The tail current setting enables the absorption stage to be ended early based on charge current. If the charge current drops below the tail current threshold for one minute, the absorption stage will immediately end and the charger will move to float or storage stage.

iv. **Repeated absorption**

The repeated absorption time setting enables the elapsed time between each automatic refresh charge cycle (1h in absorption stage) to be configured. Repeated absorption is enabled by default and can be disabled which results in the battery staying in storage mode indefinitely. The repeated absorption is not executed.

d. **Recondition**

i. **Recondition current percentage**

The recondition current percentage is used to establish the charge current limit while the charger is in recondition stage; the percentage is relative to the configured 'Maximum charge current'. The charger will limit charge current to this lower level while in recondition stage.

ii. **Recondition stop mode**

The recondition stop mode setting allows selection between the recondition stage being ended upon the battery voltage reaching the recondition stage voltage setpoint or a fixed time period.

iii. **Maximum recondition duration**

The recondition time setting enables the maximum recondition time or the fixed recondition time to be configured (depending on the recondition stop mode selected).

iv. **Manual recondition**

Manual recondition can be started by tapping on the START NOW button. The duration of the recondition cycle is limited to a maximum of 1 hour.

8.3. Power supply function

The Victron **Phoenix Smart IP43 Charger** range are also suitable for use as a DC power supply, to power equipment without a battery connected (or while also connected to a battery).

While it's still possible to use the charger as a power supply without changing any settings, a dedicated 'Power supply' mode exists for this purpose/usage.

If the charger will be used as a power supply, it is recommended to activate 'Power supply' mode, as it will disable the internal charge logic and provide a constant DC supply voltage.

To activate power supply mode:

- Access the 'settings' menu by selecting the 'settings' icon (gear) in the top right corner.



- Select the 'Function' dropdown arrow to expand the menu, then select 'Power supply' mode.

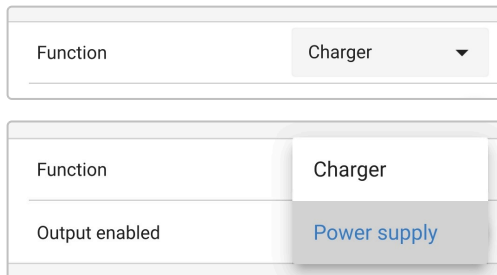

- 'Power supply' mode will now be enabled; once activated the BULK, ABS, FLOAT and STORAGE LEDs will be illuminated.



- If required, adjust the desired output voltage and/or the 'Maximum current' limit.

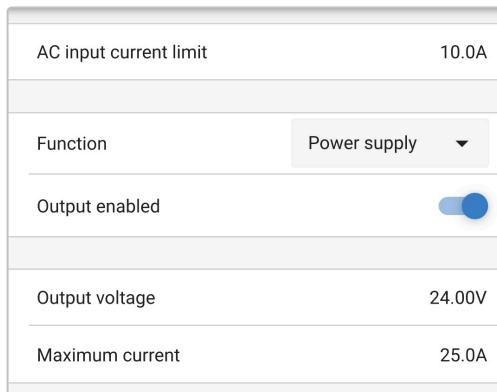

To return the charger back to normal use as a battery charger, access the 'settings' menu and in the 'Function' drop down menu select 'Charger' mode again.

9. Technical specifications

Specification	12/30 (1+1) & (3)	12/50 (1+1) & (3)	24/16 (1+1) & (3)	24/25 (1+1) & (3)
Nominal input voltage - AC supply	120 – 240VAC			
Input voltage range – AC supply	85 – 250VAC (full power from 100VAC, startup from 90VAC)			
Input frequency - AC supply	45 - 65Hz			
Input voltage - DC supply	90 - 375 VDC			
Power factor	>0.99			
Max Efficiency - 230VAC / 120VAC	95% / 93%	94% / 92%	96% / 94%	96% / 94%
Charge voltage - Absorption / Float / Storage	Normal: 14.4V / 13.8V / 13.2V High: 14.7V / 13.8V / 13.2V Li-ion: 14.2V / N/A / 13.5V		Normal: 28.8V / 27.6V / 26.4V High: 29.4V / 27.6V / 26.4V Li-ion: 28.4V / N/A / 27.0V	
Temperature compensation (N/A for Li-ion)	-16mV/°C		-32mV/°C	
Charge algorithm	6-stage adaptive (3 stage for Li-ion)			
Max output current - Normal mode	30A	50A	16A	25A
Max output current - Low current mode	15A	25A	8A	12.5A
Max output current - Starter battery	4A (1+1 output models only)			
Back drain current	<1mA			
Max battery capacity (recommended)	300Ah	500Ah	160Ah	250Ah
Min battery capacity - Normal mode	Lead: 120Ah Li-ion: 60Ah	Lead: 200Ah Li-ion: 100Ah	Lead: 64Ah Li-ion: 32Ah	Lead: 100Ah Li-ion: 50Ah
Min battery capacity - Low current mode	Lead: 60Ah Li-ion: 30Ah	Lead: 100Ah Li-ion: 50Ah	Lead: 32Ah Li-ion: 16Ah	Lead: 50Ah Li-ion: 25Ah
Data communication	VE.Direct and Bluetooth (via VictronConnect app)			
Bluetooth power and frequency	-4dBm 2402 - 2480MHz			
Remote on/off	Yes (2 pole terminal)			
Programmable relay	Yes (SPDT - 5A up to 250VAC / 5A up to 28VDC)			
Operating temperature	-20 to +60°C (0 - 140°F) Full rated output up to 40°C			
Max humidity	95%			
Enclosure				
Material and colour	Aluminium Blue RAL 5012			
AC connection	IEC 320 C14 inlet with retainer clip (AC cord ordered separately)			
Battery connection	Screw terminals 16 mm ² (AWG6)			
Number of battery connections	(1+1) models: 2 (2nd output via 2 pole terminal) (3) models: 3			
Protection category	Electronic components: IP43 Connection area: IP22			
Weight	2.7 kg (6.0 lbs)			
Dimensions (h x w x d)	180 x 249 x 116mm (7.1 x 9.8 x 4.6 inch)			
Compliance standards				
Safety	EN 60335-1, EN 60335-2-29			
Emission	EN 55014-1, EN 61000-6-3, EN 61000-3-2			
Immunity	EN 55014-2, EN 61000-6-1, EN 61000-6-2, EN 61000-3-3			
Vibration	IEC68-2-6:10-150Hz/1.0G			

10. Warranty

This limited warranty covers defects in materials and workmanship in this product, and lasts for five years from the date of original purchase of this product.

The customer must return the product together with the receipt of purchase to the point of purchase.

This limited warranty does not cover damage, deterioration or malfunction resulting from alteration, modification, improper or unreasonable use or misuse, neglect, exposure to excess moisture, fire, improper packing, lightning, power surges, or other acts of nature.

This limited warranty does not cover damage, deterioration or malfunction resulting from repairs attempted by anyone unauthorized by Victron Energy to make such repairs.

Victron Energy is not liable for any consequential damages arising from the use of this product.

The maximum liability of Victron Energy under this limited warranty shall not exceed the actual purchase price of the product.